



CNG CONVERSION SYSTEM INSTALLATION MANUAL

2014 FORD F-150 3.7L BI-FUEL



INTRODUCTION

Note: Before beginning installation, we encourage you to read the installation manual thoroughly and familiarize yourself with the install.

1. Do a quick inventory check using the provided packing slip and make sure your kit is complete. You can also refer to the parts list located in the back of the manual. If you discover shipping damage or a missing component, please contact Altech-Eco immediately.
2. Review our limited warranty with care.
3. Make sure safety is a priority by wearing eye protection, steel toe boots, keep your work area clean and always be aware of your surroundings.
4. No smoking near or around your work area during any portion of the install.
5. Never work on a hot engine.
6. Obey all traffic laws when testing the vehicle.
7. Always do a clean snip of all zip ties.
8. Clean up all debris caused by the installation.
9. Read and be familiar with the latest NFPA 52 codes and safety procedures for dealing with natural gas before you begin the install.
10. Make sure all proper paperwork is filled out before, during, and after the install. The paperwork packet will be provided to you by Altech-Eco.
11. Never attempt to modify the fuel system and always have the fuel system maintenance performed at an authorized dealership by qualified technicians.
12. Dedicated systems – Always leave at least ¼ tank of gasoline in the tank to avoid low fuel light on the vehicle dashboard display.

pg. 3	Required/recommended Tool List
pg. 4	Before Installation
pg. 5	Preparing the Truck Bed
pg. 6-9	Installing the Fuel Tank 8.9 GGE Short Bed
pg. 10-11	Installing the Fuel Tank 15.7 GGE Short Bed
pg. 12-13	Installing the Fuel Tank 21.2 GGE Short Bed
pg. 14-17	Installing Fuel Fill
pg. 18-19	Making the High Pressure Connections
pg. 20	Low Pressure Routing
pg. 21	Coolant Hoses Routing
pg. 22	Connecting Coolant Hoses to Engine
pg. 23	Rear Harness Routing
pg. 24-28	Installing Bi-fuel Components on Engine
pg. 29-31	Installing the Main Wiring Harness
pg. 32	Wiring Routing Diagram
pg. 33-34	Main. Rear, Switch Gauge Harness Layout
pg. 35	Installing AFCM Bracket
pg. 36-37	Installing Pigtail CAN BUS
pg. 38-41	Installing Switch/Gauge
pg. 42	Leak Testing the System
pg. 43-44	Installing the Cylinder Cover -8.9 GGE
pg. 45-46	Installing the Cylinder Cover -21.2 GGE
pg. 47	Decal Placement
pg. 48	Contact Information
pg. 49-50	Parts List

!! WARNING !! Follow instructions as directed in the installation manual and do not attempt shortcuts. Follow proper safety procedures. Failure to do so can lead to bodily harm or fatality. Tampering with or improperly maintaining the high pressure fuel system can also result in bodily harm or fatality.

!! WARNING !! Batteries normally produce explosive gas. Therefore, do not allow flames, sparks or lighted substances to come near the battery. When charging or working near a battery, always shield your face and protect your eyes. Always provide ventilation. Failure to follow these instructions may result in personal injury.

!! CAUTION !! Be aware that this installation requires the use of High Pressure, Flammable, and Highly Explosive compressed natural gas. CNG is stored under at maximum of 3,600psi and at 70°F (21°C).

!! CAUTION !! Failure to complete the pre-installation checklist may result in severe engine damage after installation is complete.

!! CAUTION !! This installation is intended for unmodified vehicles. If the vehicle has been modified, consult Altech-Eco before the beginning install.

DISCLAIMER

Altech-Eco assumes no responsibility for damages occurring from accident, misuse, abuse, improper installation, improper operation, and lack of reasonable care or all previously stated reasons resulting in incompatibility with other manufacturer's products.

Chemicals and Lubricants

1. Silicone lubricant spray is required on all o-rings on fittings.
2. Epoxy primer or equivalent to rust proof any exposed metal.
3. Ford approved coolant liquid to top off the reservoir.

On Bi-Fuel systems gasoline shall not remain uncirculated for extended periods of time (over 60 days).

2014 FORD F-150 3.7L COMPRESSED NATURAL GAS CONVERSION SYSTEM INSTALLATION INSTRUCTIONS

REQUIRED/RECOMMENDED TOOL LIST FOR ALTECH-ECO CNG CONVERSIONS

Recommended /Required Tools and Supplies (F-Series)

1. CNG MyCanic
2. Wire Strippers.
3. Soldering Kit w/ Heat Gun and Solder.
4. Black Electrical Tape.
5. Impact Drill.
6. Hand Drill.
7. Zip Tie Clippers.
8. Hose Clamp Tool/Pliers.
9. Hose Clamps (to restrict fluid flow).
10. Hose Cutters.
11. Socket: 5.5mm, 7mm- 13mm (Deep well and Short).
12. Ratchet: 3/8", 1/4" drive.
13. Screw Driver: Phillips head and flat head.
14. 6" Extension, 1/4" drive.
15. Wrench: 3/4", 7/8", 11/16", 1", 1/2", 19mm, 20mm, 21mm.
16. Manifold Plug Remover (Altech-Eco).
17. Terminal Removal Tool.
18. Torque Wrench: Electric and Manual.
19. Chisel/file: Half Round and Flat.
20. Hole Saw bit: 2 1/8", 2 1/2".
21. Methane Detector – One can be recommended by Altech-Eco.
22. Knife/Blade.
23. Filter Socket (Altech-Eco).
24. Drill Bit: 3/8", 3/4" Drill Bit.
25. Self Tapping screw socket heads: 5/16", 3/8".
26. Tape Measure.
27. Soap Water.

CHECK LIST:

1. Confirm packing slip to insure that you have received all components, assemblies and sub-assemblies.
2. Make sure non of the components and assemblies have been damaged in shipping.
3. Pre-inspect the vehicle following the QVM Q185 and NFPA 52 regulations (Contact ALTECH-ECO for the inspection check list).
4. Begin your conversion process.
 - Cylinder Installation
 - Regulator assembly installation
 - Fuel fill installation
 - High pressure line installation and routing
 - Low pressure and coolant line installation and routing
 - Underhood installation
 - Wiring (Including Switch and gauge) Installation
 - Decal placement
 - Fill and leak test
 - Begin your QC Process
5. Check Tire Pressure before test driving.
6. Check and fill coolant fluid before starting and test driving.
7. Be sure the rear harness is routed properly and is not loose under vehicle.
8. Be sure all provided parts are installed.
9. Final test drive.

THIS DOCUMENT CONTAINS PROPRIETARY DATA OF ALTECH-ECO AND SHALL NOT BE USED OR DISCLOSED IN WHOLE OR IN PART TO DESIGN OR FABRICATE ANY PRODUCT FOR ANY PURPOSE, NOR REPRODUCED OR TRANSMITTED TO ANY OTHER ORGANIZATION WITHOUT THE EXPRESS PERMISSION OF ALTECH-ECO.

Before Installation

FIRST:

Disconnect the negative terminal from the vehicle battery. Battery is to stay disconnected until a fully CNG system is installed. The vehicle battery may be reconnected before the toolbox/cover installation; connecting the vehicle battery is necessary for leak testing.



PREPARING THE TRUCK BED

Drill Line and Harness Hole in Truck Bed

A hole must be drilled in the truck bed to accommodate the low pressure fuel line, the coolant lines, the fill line and the electrical harness. This applies to all vehicle fuel system installations.

Some original parts may be reused or will remain in place after the installation of the CNG system. Cylinder mounting will use existing OEM bolt holes to secure the mounting plates.

Tools:

- Tape Measure
- Center Punch
- Drill
- 1" Hole Saw
- Motorcraft Premium Undercoating (PM-25-A) or equivalent

1. To locate the grommet hole location, measure 8" from the front inside of the bed and 5 3/4" over from the seam in the bed floor toward the left inside of the bed. Refer to diagram.
2. In the measured location, use a center punch to mark the drill spot. This will be used as your guide. Remember that some of the models will have rhino plastic lined beds.
3. Using the drill and hole saw, bore a 2 1/2" hole in the bed. Use caution when drilling the hole so that the saw teeth do not damage something below the bed. Clean any debris. Deburr the drilled hole.
4. Use the undercoating or equivalent, spray the hole to seal the metal from corrosion and let dry.
5. Install the 2 1/8" grommet (2 1/8GRW) into the 2 1/2" hole.

Grommet hole size is the same for both short bed and long bed F-150 truck

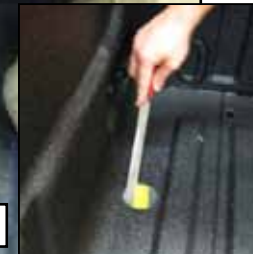
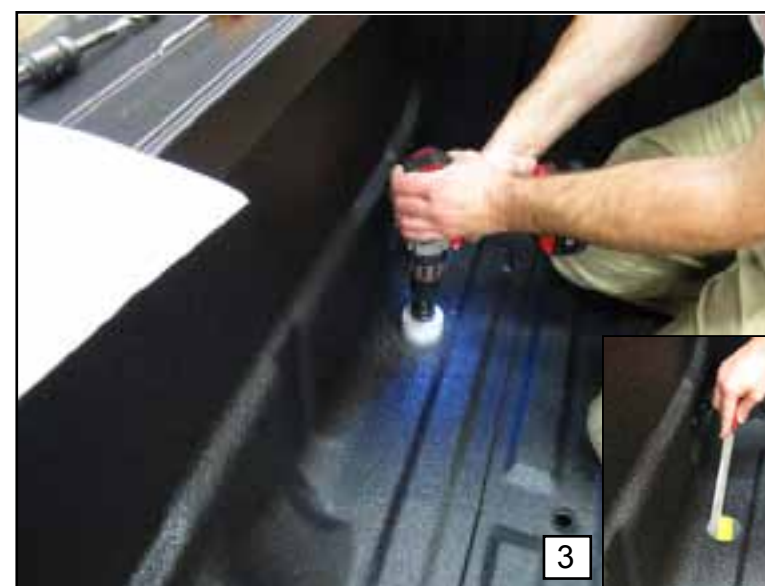
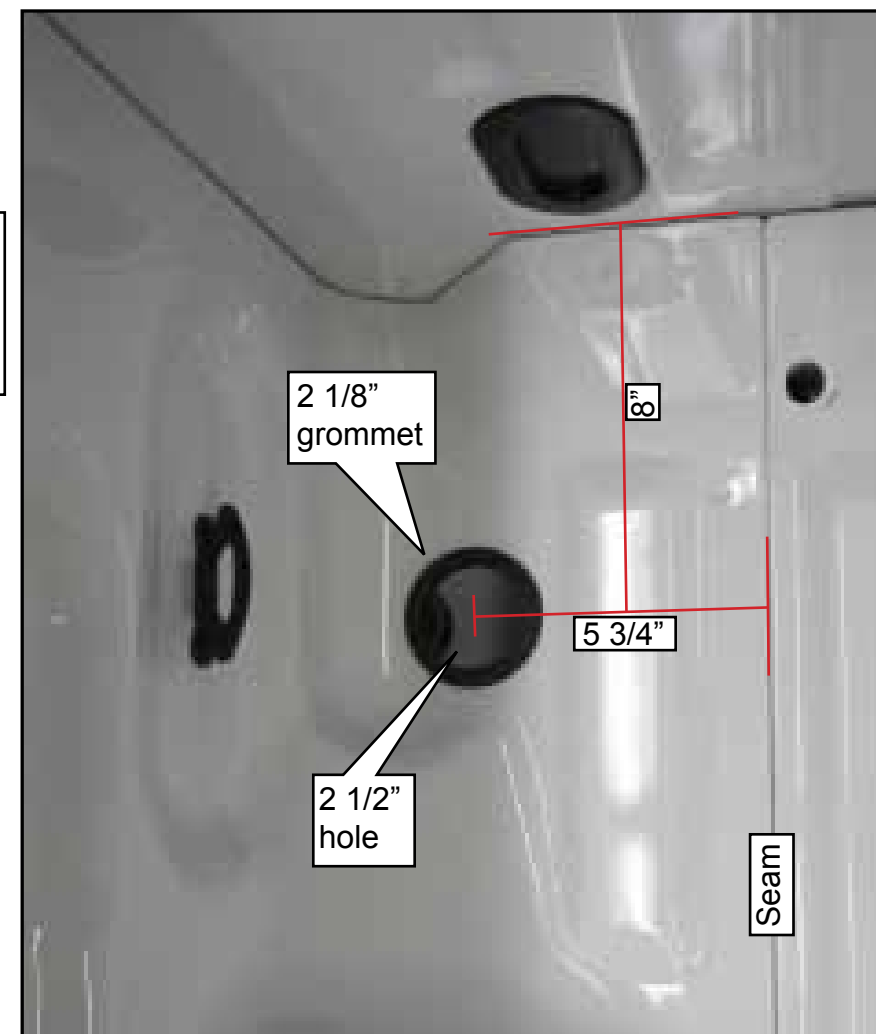

8.9 GGE FUEL TANK PACKAGE, Short Bed (6.75')

Drill Tank Mounting Plate Holes in Truck Bed

NOTE: Please refer to *PREPARING THE TRUCK BED* section for grommet hole that will be used for all lines and harnesses entering the bed of the truck.

1. Begin by removing the two OEM bolts nearest to the cab. Discard the bolts.
2. Carefully place the assembled cylinder package into the truck bed.
3. Place two 110mm bolts (149) into the OEM bolt holes nearest the cab. Hand start the bolts. This will keep the cylinder package from shifting.
4. Mark the three holes located on the rear plate.

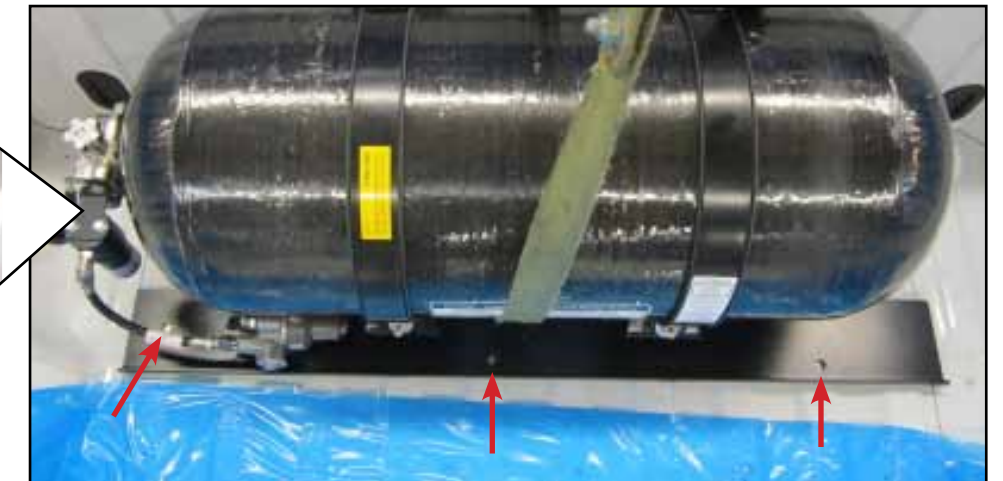
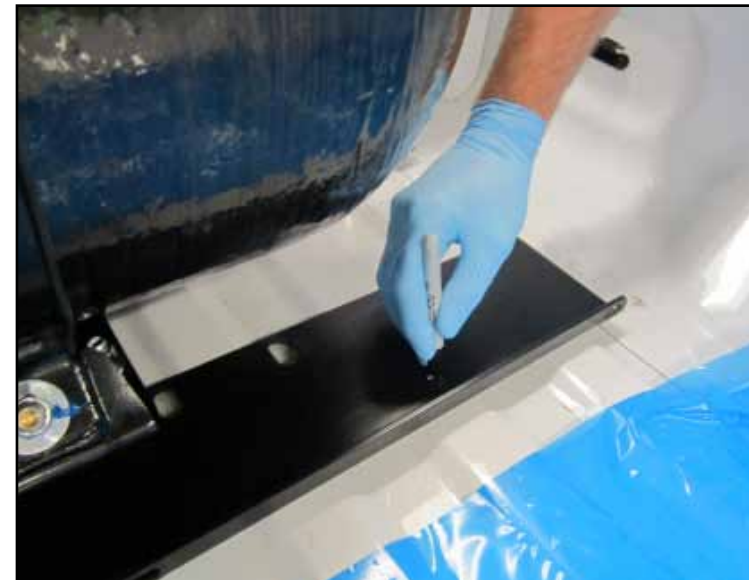

Mark these three holes.

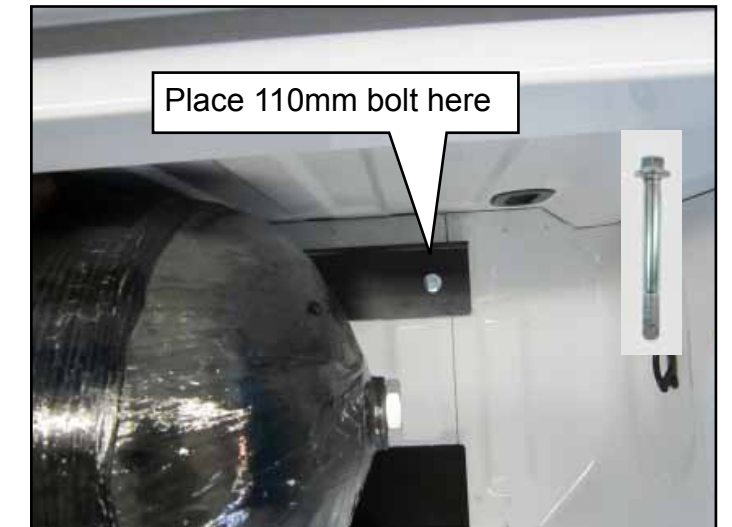
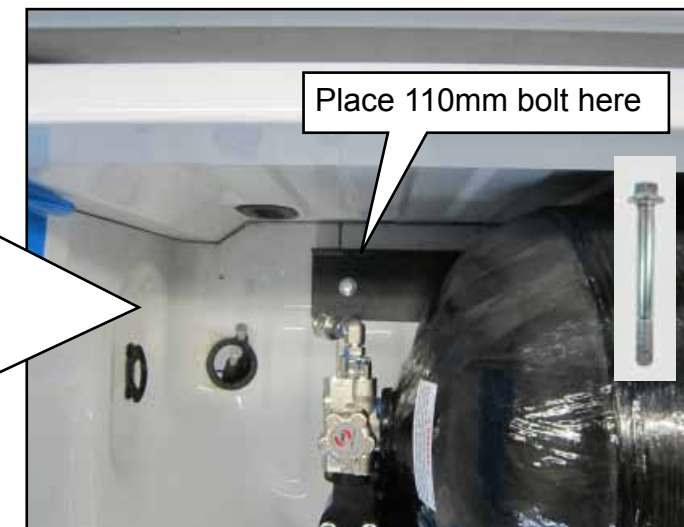
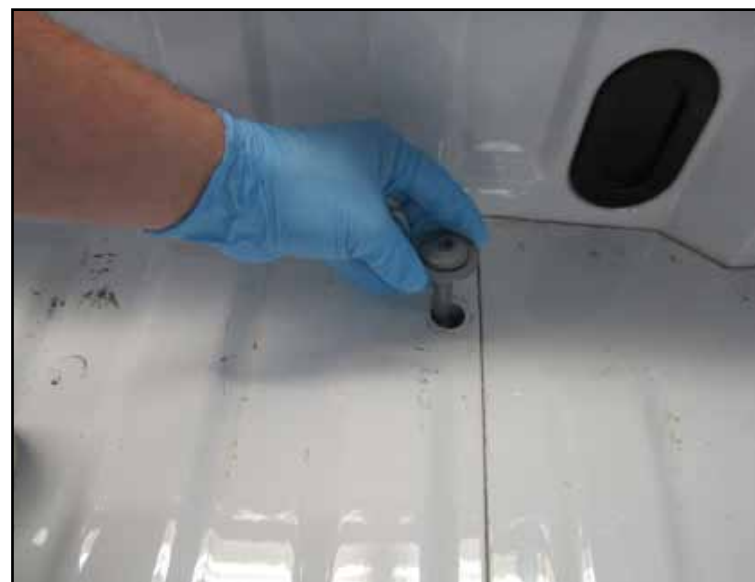

8.9 GGE FUEL TANK PACKAGE, Short Bed (6.75')

Drill Tank Mounting Plate Holes in Truck Bed

5. Verify that the measurement from bed wall to cylinder rear plate is 17". Note, the front plate two main anchoring bolt holes will be slotted, so there may be a 3/4" margin for package movement. Furthest distance allowed from bed wall is 16 3/4"-17".
6. Carefully remove the cylinder package.
7. Refer to the diagram and verify your measurements.

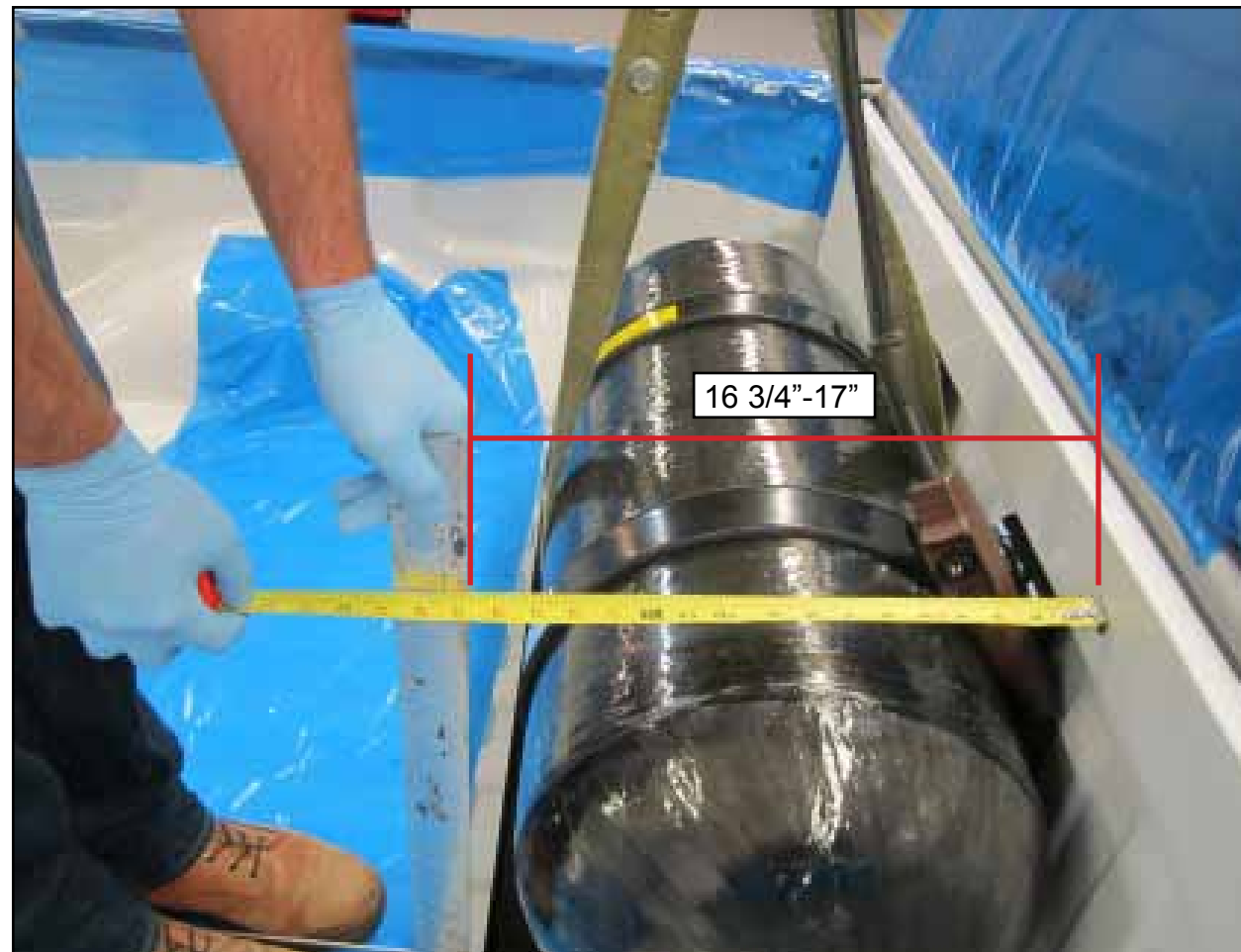

8.9 GGE FUEL TANK PACKAGE, Short Bed (6.75')

Drill Tank Mounting Plate Holes in Truck Bed

8. Drill a pilot hole first and verify measurements again. Ensure there is no obstruction underneath the vehicle.
9. Drill a 9/16" size hole for all three locations.
10. Deburr and rust proof the holes.
11. Place the cylinder package back onto truck bed.
12. From beneath the vehicle, install 3 1/2" bolts (124-H) along with a 2x2x1/8 spacer (SP2X2X1/8) into each three holes. Thread must be facing up. Secure the bolts with a nylock nut (043) and a 1/2 flat washer (040). Torque to 70 ft-lbs.



8.9 GGE FUEL TANK PACKAGE, Short Bed (6.75')

Drill Tank Mounting Plate Holes in Truck Bed

- 13. Install the two (149) bolts into the OEM bolt holes. Torque to 70 ft-lbs.

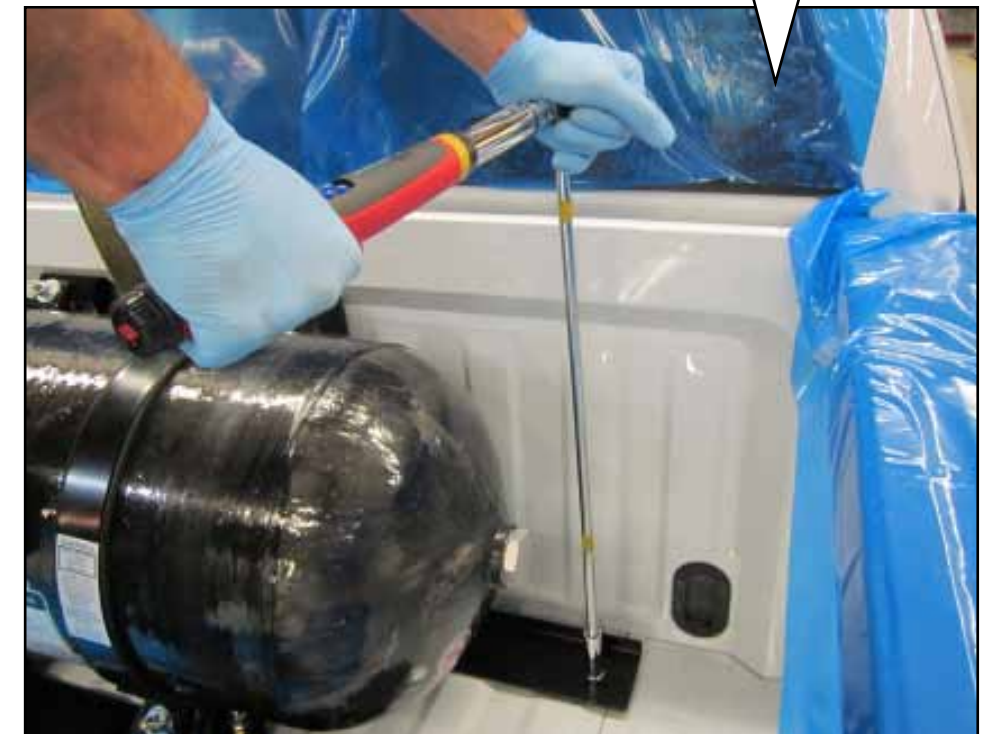

15.7 GGE FUEL TANK PACKAGE, Short Bed (6.75')

Drill Tank Mounting Plate Holes in Truck Bed

Refer to *PREPARING THE TRUCK BED* section to instal a grommet and grommet hole.

1. Remove the two OEM bolts nearest to the cab. Discard the OEM bolts.
2. Refer to shown diagram and mark the drill points.
3. Drill a pilot hole first and verify measurements. Then drill the same holes to 9/16" size.
4. Deburr and rustproof any exposed metal.
5. Carefully Lower the cylinder package into the bed. For easier placement, angle the cylinder with plug side facing slightly down and place cylinder package into the bed this way. This is to prevent any potential damage to the fittings while placing the cylinder package.

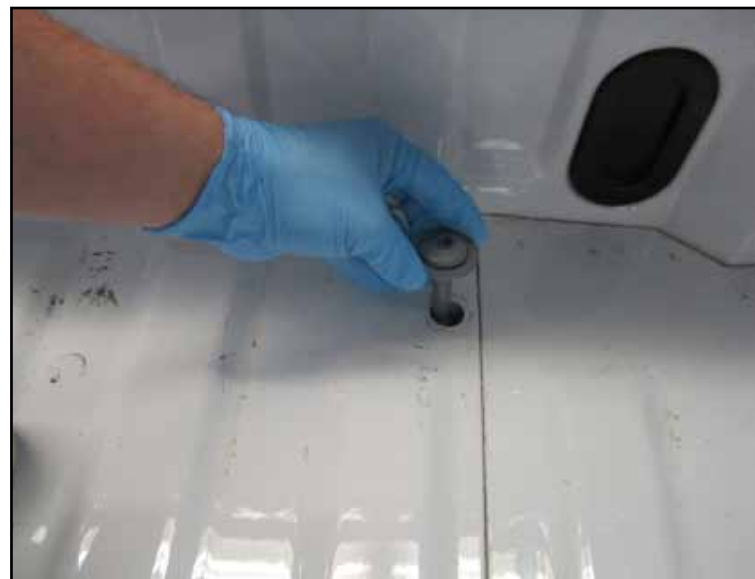
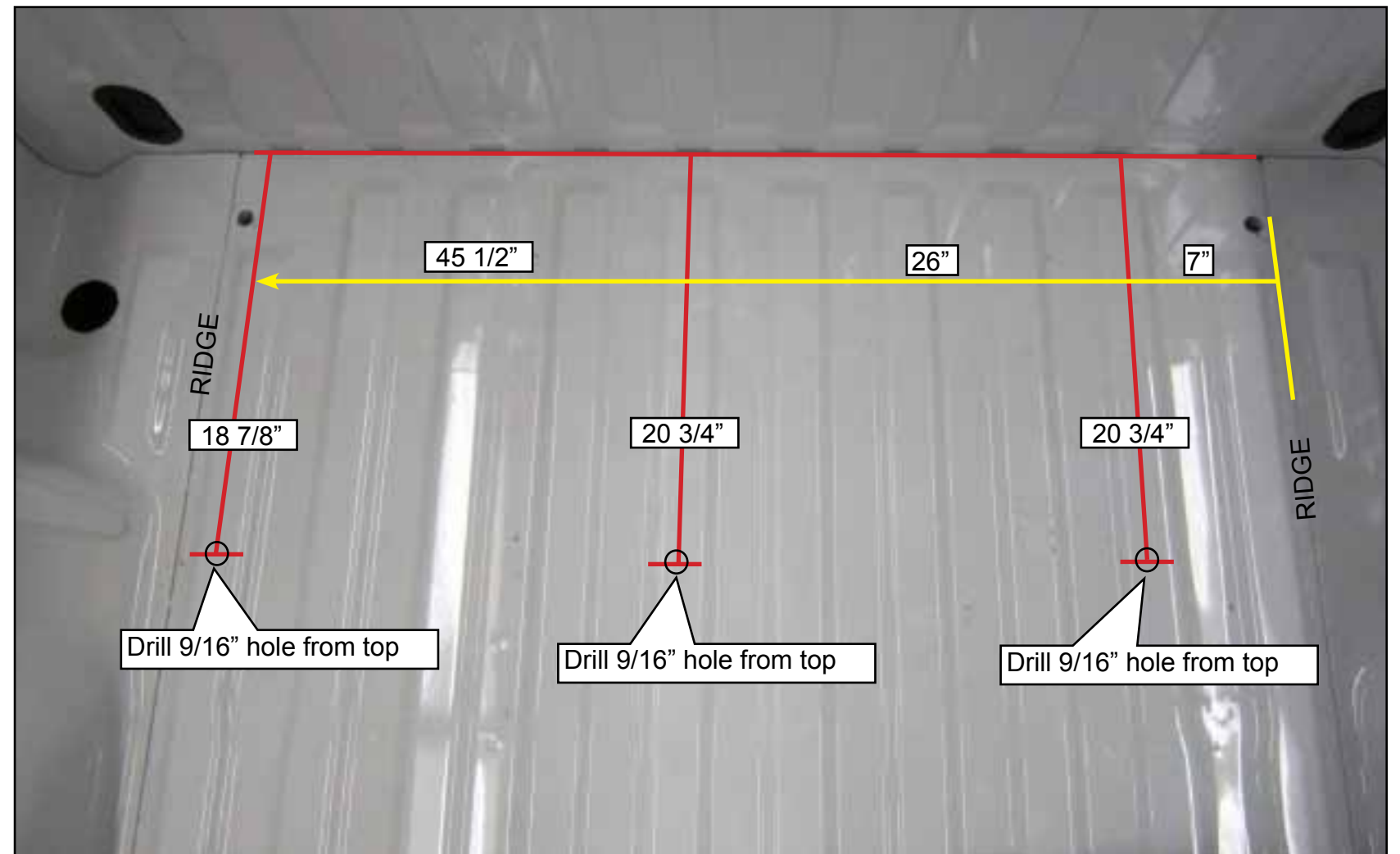

15.7 GGE FUEL TANK PACKAGE, Short Bed (6.75')

6. Using the 110mm bolts (149), secure the front plate to the bed of the truck. Hand start the bolts, but do not tighten.
7. For the rear plate, use 1 1/2" bolts (124-H) combined with the 2x2x1/8 spacers. Secure the plate by placing these bolts from underneath the vehicle. The thread must be facing up. The should be located underneath the vehicle. Tighten to 70 ft-lbs.
8. Apply QVM cover decal on strap closest to the valve.

Refer to *COOLANT HOSES, REAR WIRE HARNESS, LOW PRESSURE HOSE AND FUEL FILL CONNECTION TO CYLINDER PACKAGE* section for making the necessary connection to the 15.7 GGE high pressure package.

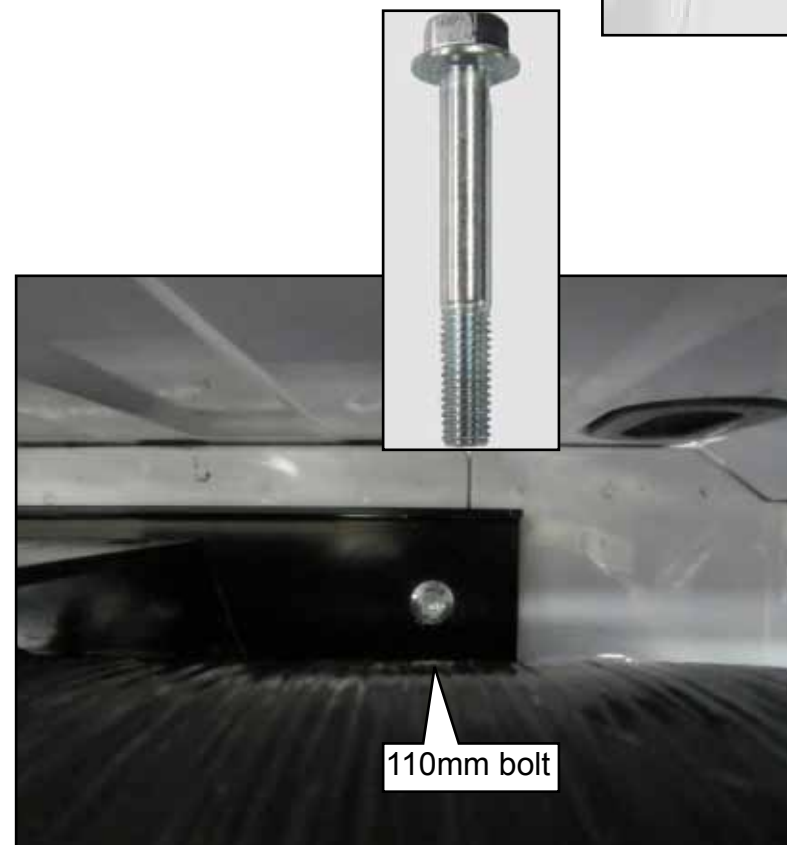
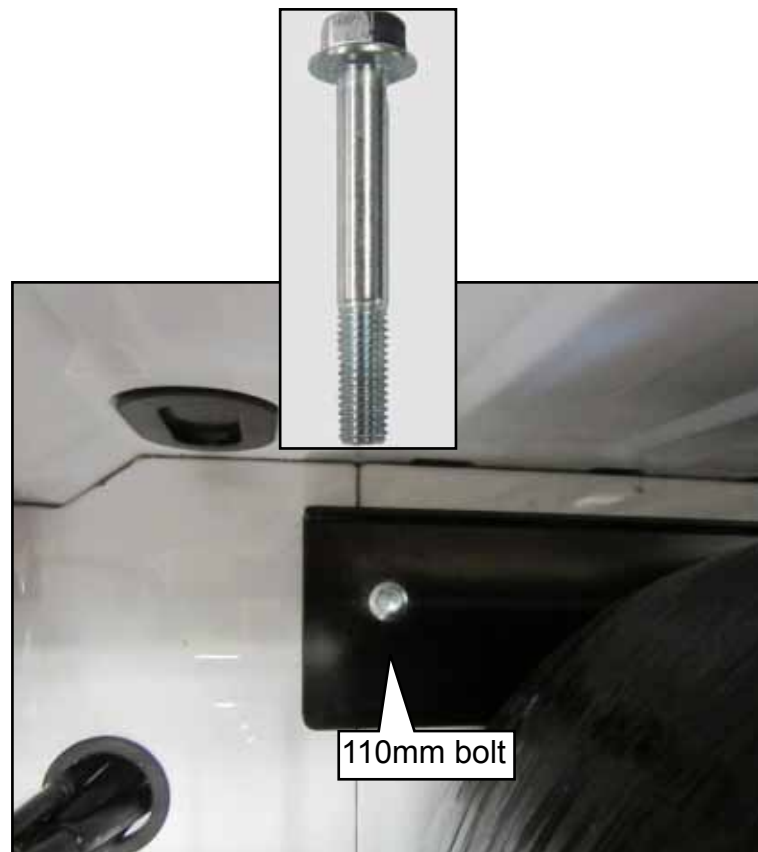

21.2 GGE FUEL TANK PACKAGE, Short Bed (6.75')

Preparing a Short Bed for Fuel Tank Install

Ford F-150 trucks with a short bed must have the bed floor drilled to accommodate the fuel tank rear mounting plate bolts. Some original parts may be reused or will remain in place after the installation of the CNG system. The components in this section may be saved, discarded, or new. Refer to the color key.

Tools:

- Basic Hand Tools
- Center Punch
- Drill
- 3/4" Hole Saw
- Motorcraft Premium Undercoating (PM-25-A), epoxy primer, or equivalent

1. Mark the drilling locations for the two rear tank bed bracket bolts.
2. Measure from the front of the bed to the rear 25". Mark the locations. Then from the mark, measure outward the ridge 4 1/2". Mark the location. Repeat on opposite side. Refer to Diagram B.
3. The distance between the two rear marks must be 39" apart and the marks will fall in the center of the valleys between the ridges at the seams of the bed.
4. Drill two 9/16" diameter holes (one at each rear location) using the drill and a 9/16" hole saw. Drill the holes in the bed through the bed crossmember support.

Note: Drilling from under the vehicle through the crossmember hole helps to more accurately align the 9/16" hole location with the hole in the crossmember.

5. Verify that the holes align with the bed correctly according to the marked locations. Refer to Diagram B.
6. Deburr the holes and using the undercoating or equivalent, spray the holes to seal the metal from corrosion.

Long Bed (8 ft)

Preparing a Long Bed for Fuel tank Install

There is no drilling necessary for a long bed truck. The existing holes will be used to accommodate the fuel tank install.

Measure from the front of the truck bed wall

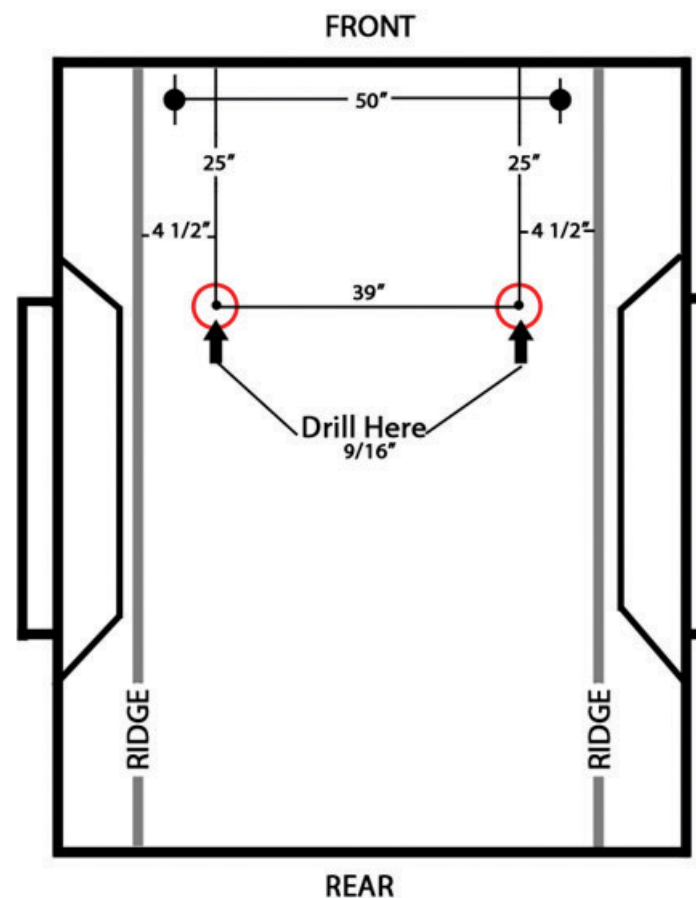
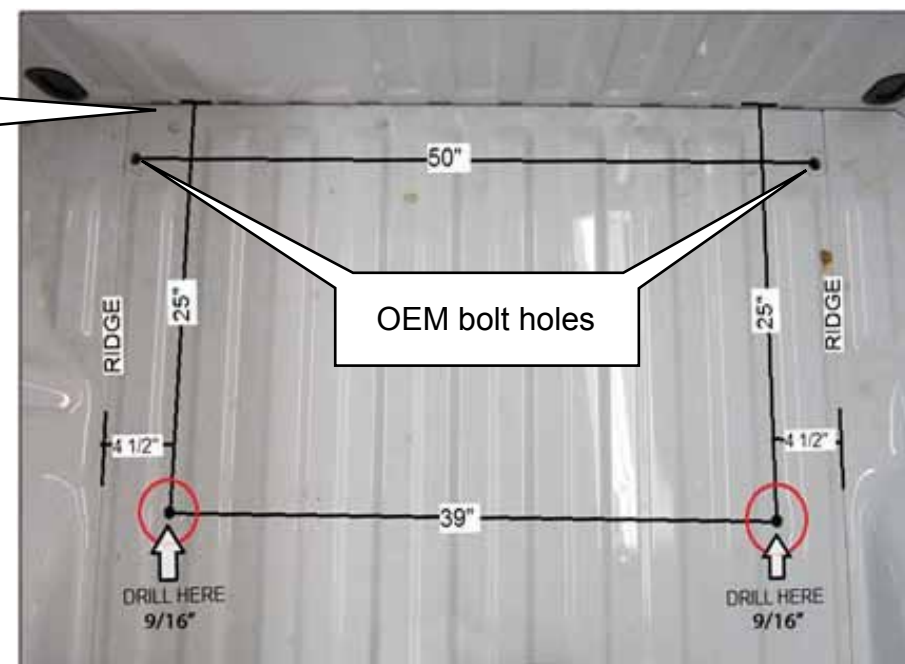

Diagram B

21.2 GGE FUEL TANK PACKAGE

Placing and Securing the Cylinder

Installing the tank is essentially the same for all vehicle models. However, the Fuel tank rear mounting plate varies according to application.

Note: Use caution when lifting the cylinder package. **Do not drop the cylinder package.**

1. With a crane hoist or equal safe means, lift the cylinder package and carefully place the assembly into the bed. Align mounting bolt holes of the mounting plates to the holes in the bed. Remove hoist strap.
2. Insert two 110mm bolts (149) into the front cylinder plate.
LONG BED - Insert two 110mm bolts into the rear plate (use OEM holes to secure).
SHORT BED - Insert two 2" bolts (147-H) into the rear plate. Insert a backing plate (F150SBCBP) into each side of the channel. Secure the 2" bolt to the backing plate. Backing plate with bolt threading must be facing inward into the channel.
3. When the tank is set, hand tighten all four bolts as to insure they are threaded correctly.
5. Tighten to 70ft-lb to insure the safest operating specifications.

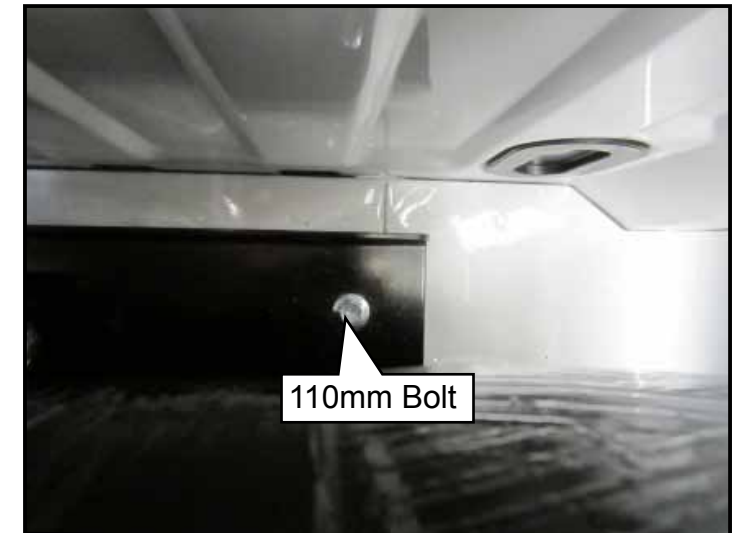

SHORT BED ONLY



This spacer (F150SBCBP) goes inside the channel, bolt thread facing inward and down going into the channel. Flush surface must be facing up.



FUEL FILL INSTALLATION

Prepping and Installing into Truck Bed - SHORT BED

1. Measure 16" x 16" and mark the drill point.
2. Drill a 1/4" pilot hole first. Double check your measurement. Then using a hole saw, drill a 2 1/2" hole.

Note: Use caution when drilling so as to not damage surrounding area.

3. Deburr and clean off any debris around the hole. Rust proof the hole to avoid corrosion.
4. Place the Fuel Fill Ring (FRR) into the hole and use it as a template and to mark the holes that will be used to secure the ring to the fuel fill cup housing. Position the ring exactly as shown.
5. Drill 3/16" holes the fuel fill ring. It is alright if you slightly enlarge the holes in the ring while drilling.

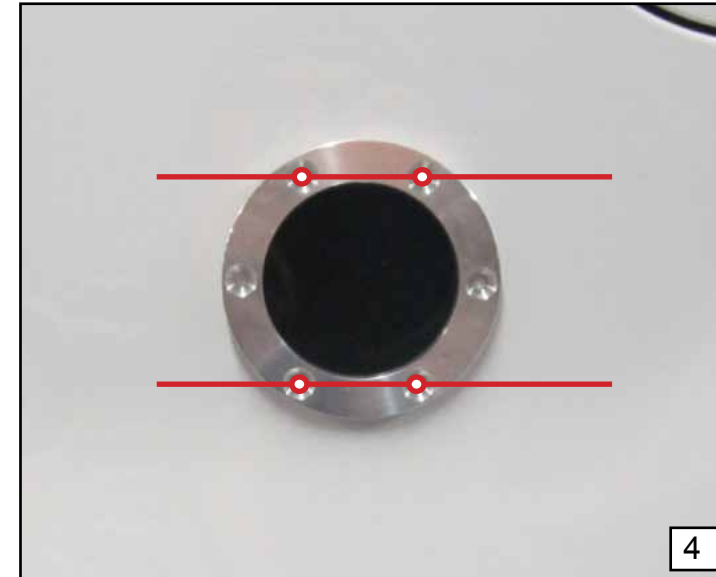
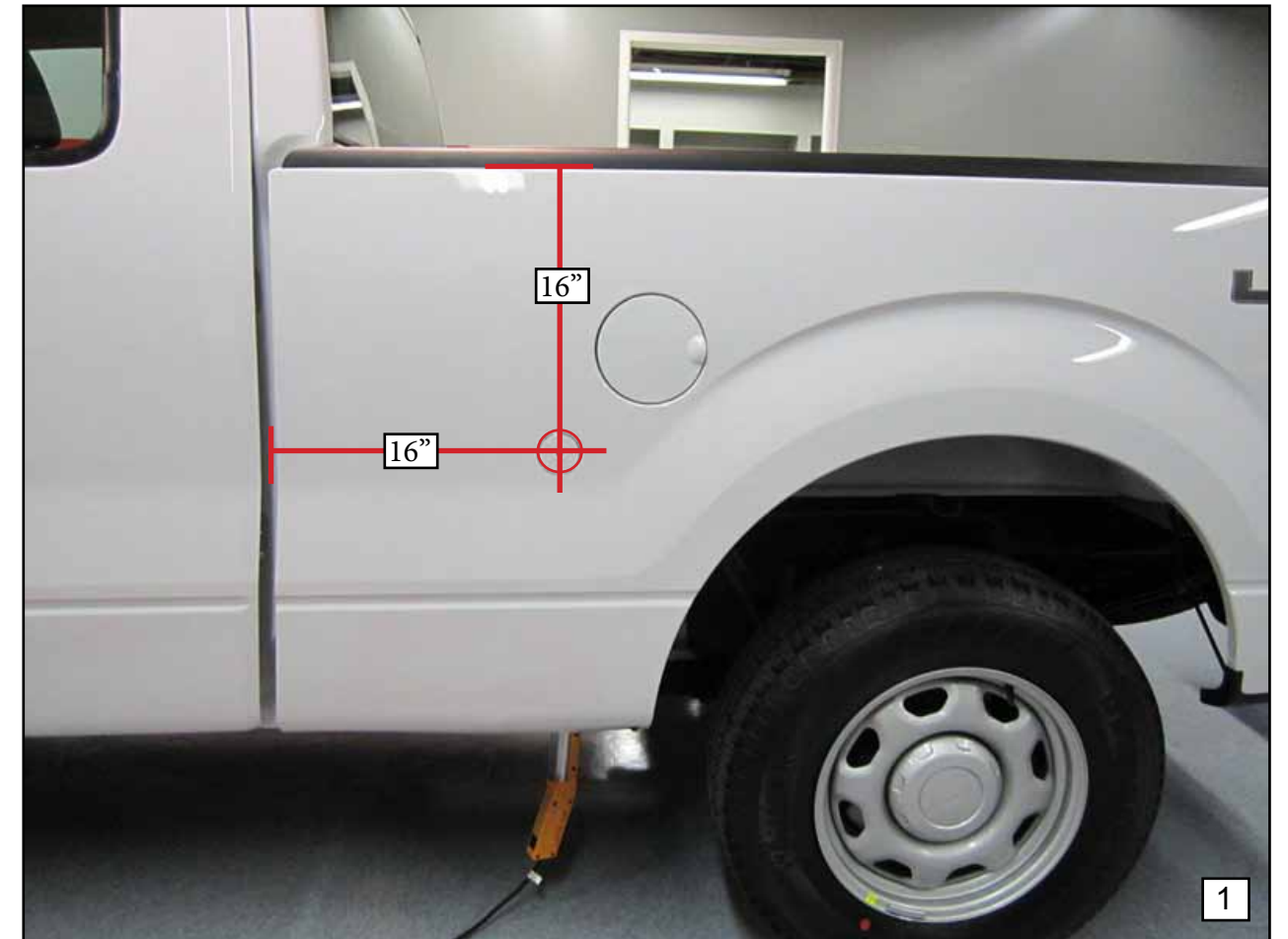

FUEL FILL INSTALLATION

Prepping and Installing into Truck Bed - LONG BED

1. Measure 34" (horizontal) x 15" (vertical) and mark the drill point.
2. Drill a 1/4" pilot hole first. Double check your measurement. Then using a hole saw, drill a 2 1/2" hole.

Note: Use caution when drilling so as to not damage surrounding area.

3. Deburr and clean off any debris around the hole. Rust proof the hole to avoid corrosion.
4. Place the Fuel Fill Ring (FRR) into the hole and use it as a template and to mark the holes that will be used to secure the ring to the fuel fill cup housing. Position the ring exactly as shown.
5. Drill 3/16" holes the fuel fill ring. It is alright if you slightly enlarge the holes in the ring while drilling.

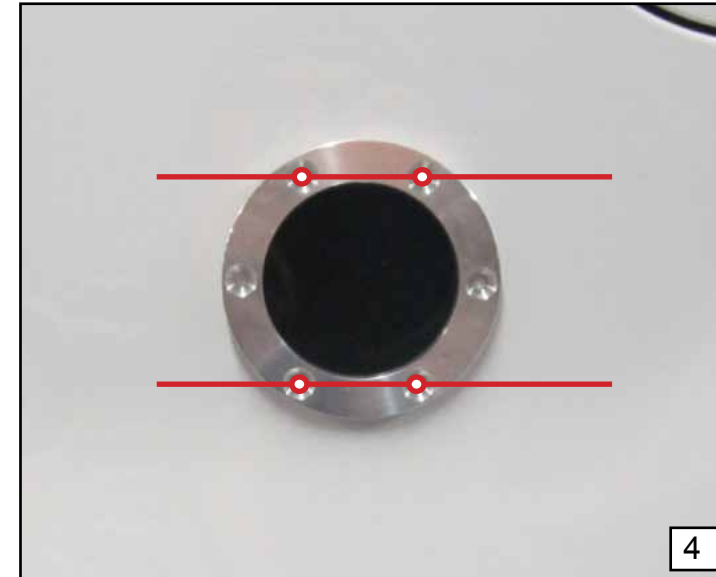
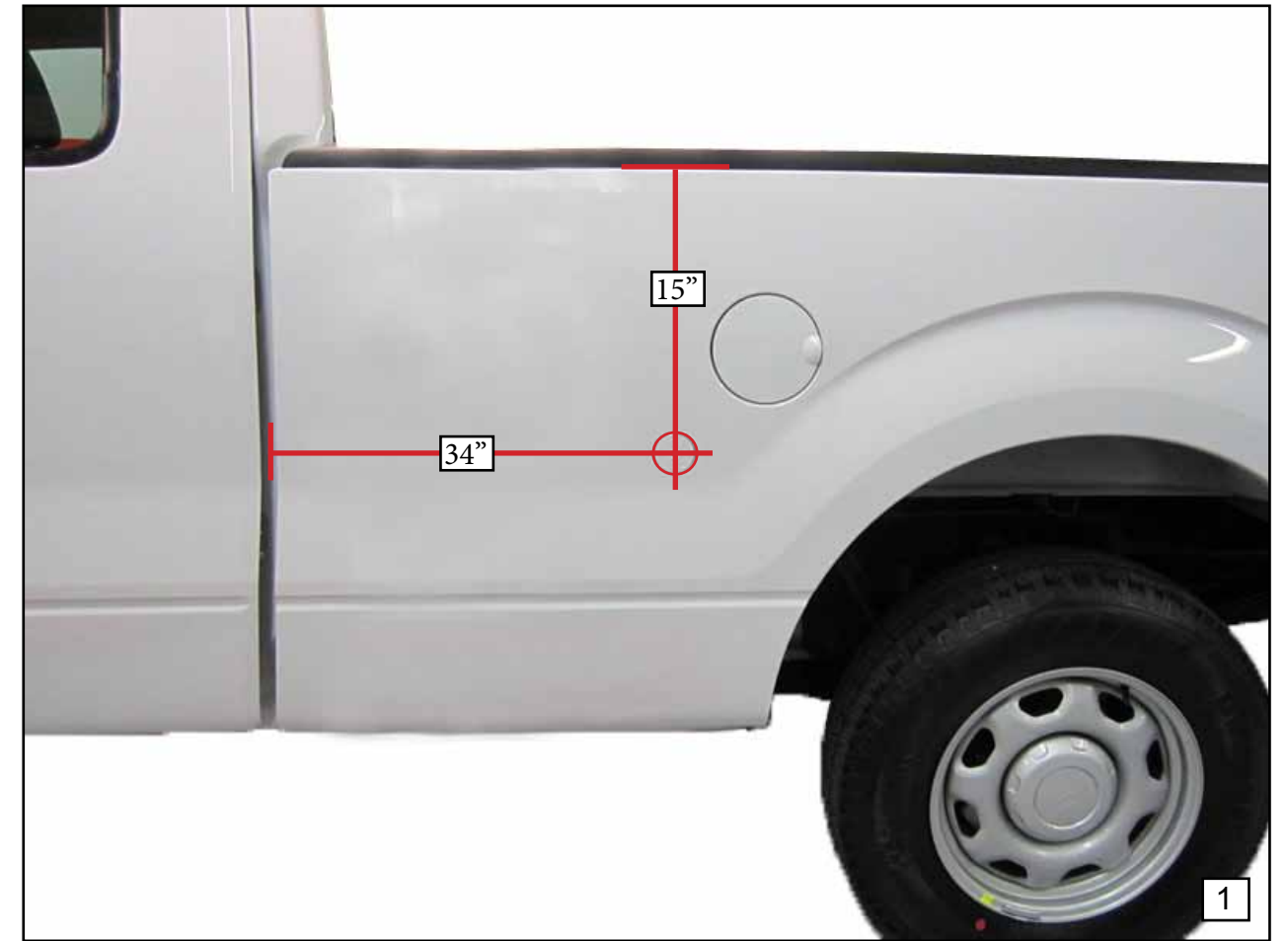

FUEL FILL INSTALLATION

Receptacle and Fitting Assembly

1. Obtain the fuel fill cup and joining components. Remove the rubber cap and the sandwich nut located on the back end off the receptacle. Rubber cap may be re-installed onto receptacle once the fuel fill installation is complete.
2. Begin with sandwiching the receptacle through fuel fill cup housing (FRH). Place the receptacle nut on the back end of the fuel fill cup housing.
3. Tighten and torque the receptacle and nut to 35 ft-lbs.
4. Combine the straight thread 90 degree elbow (6 C5OLO-SS) to the back of the receptacle. Torque to 35 ft-lbs.

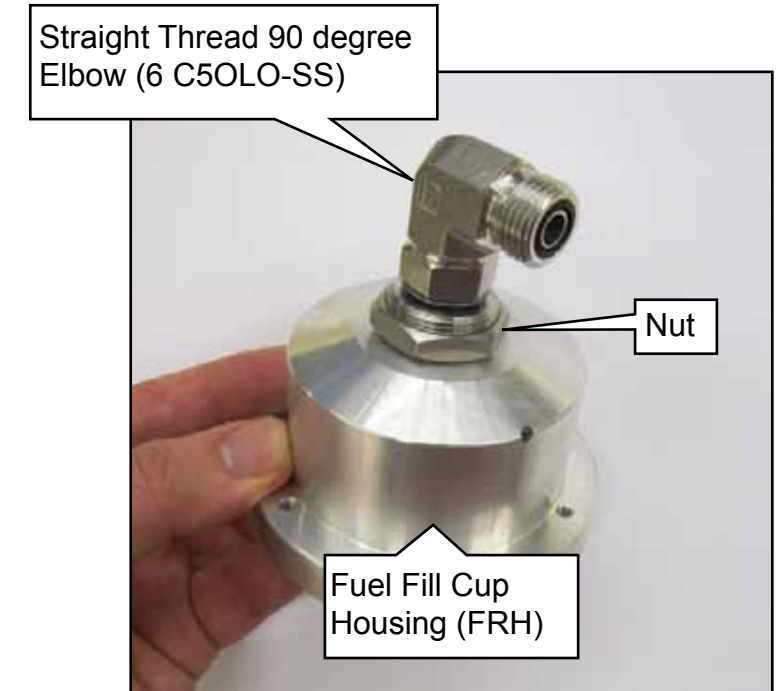

INSTALLING THE FUEL FILL

Securing and Making the Connection Points

5. Install the fuel fill cup housing with fitting behind the truck bed wall. Secure the cup housing from the front using the fuel fill housing screws. The open end of the fitting must be facing directly down. Tighten.
6. SHORT BED - Connect the 24" high pressure hose (HPH24ORFS) to the receptacle and check valve located within the bed. Tighten to 30-35 ft-lbs.
7. LONG BED 21.2 GGE - Connect the 44" high pressure hose (HPH44ORFS) to the receptacle and check valve located within the bed. Tighten each end to 30-35 ft-lbs. Secure the hose to the channel with a 5/8 p-clamp (PC5/8) and a 1" self tapping screw (135-H).

Note: When sandwiching the fuel fill ring to the fuel fill cup housing, you must secure the bolts in a criss cross method in the same manor as securing a wheel to the vehicle when changing a spare tire.

Refer to *COOLANT HOSES, REAR WIRE HARNESS, LOW PRESSURE HOSE AND FUEL FILL CONNECTION TO CYLINDER PACKAGE* page for additional connection information.



Connect the high pressure line to the check valve located facing downward from the cylinder valve.

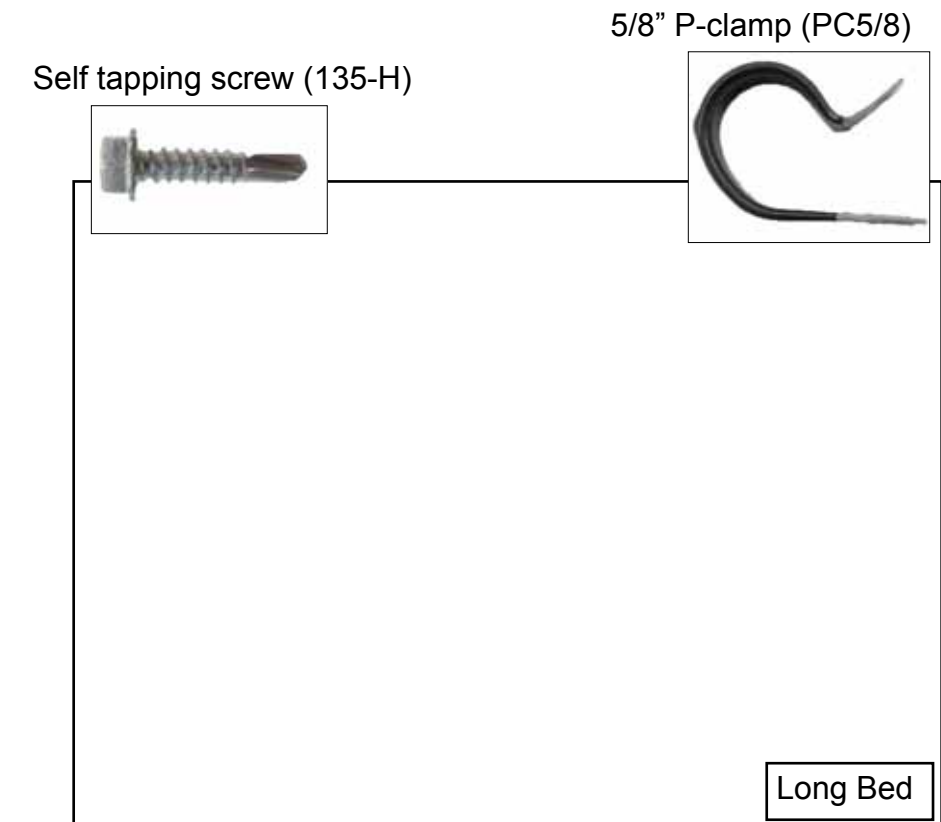
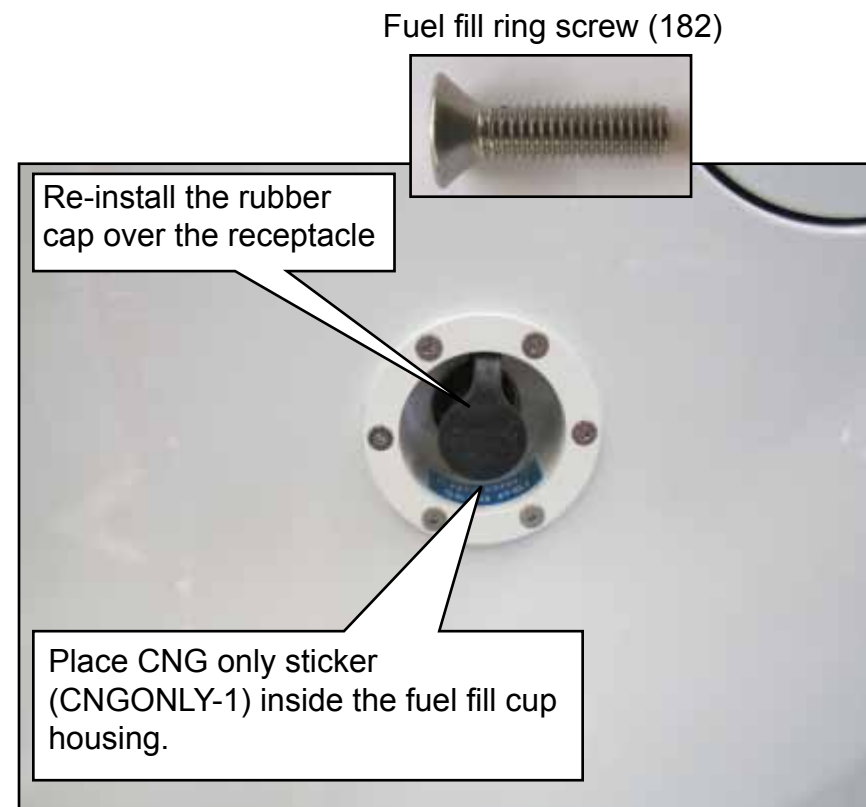
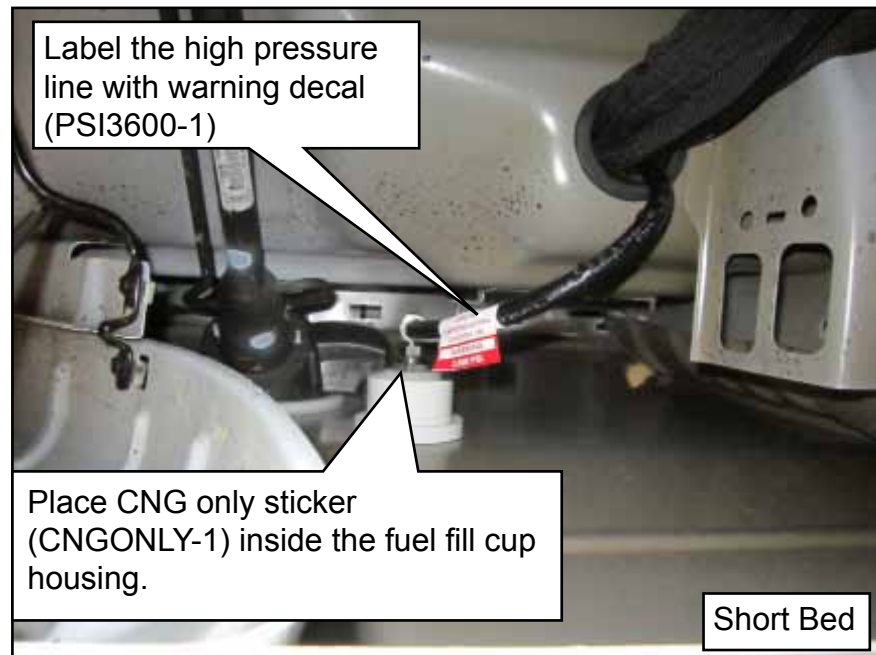

COOLANT HOSES, REAR WIRE HARNESS, LOW PRESSURE HOSE AND FUEL FILL CONNECTION TO CYLINDER PACKAGE

MAKING THE CONNECTIONS - 8.9 GGE Package

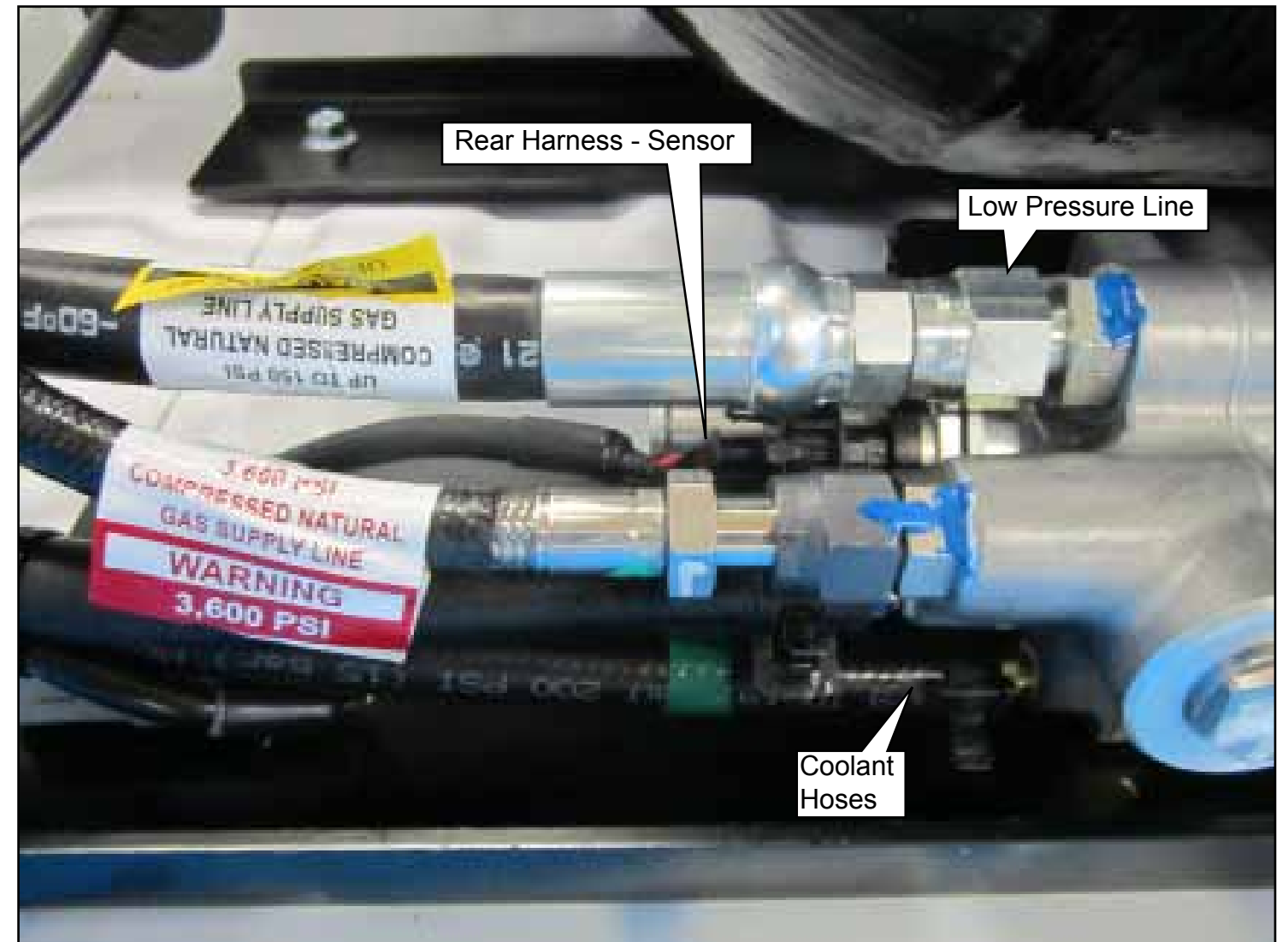
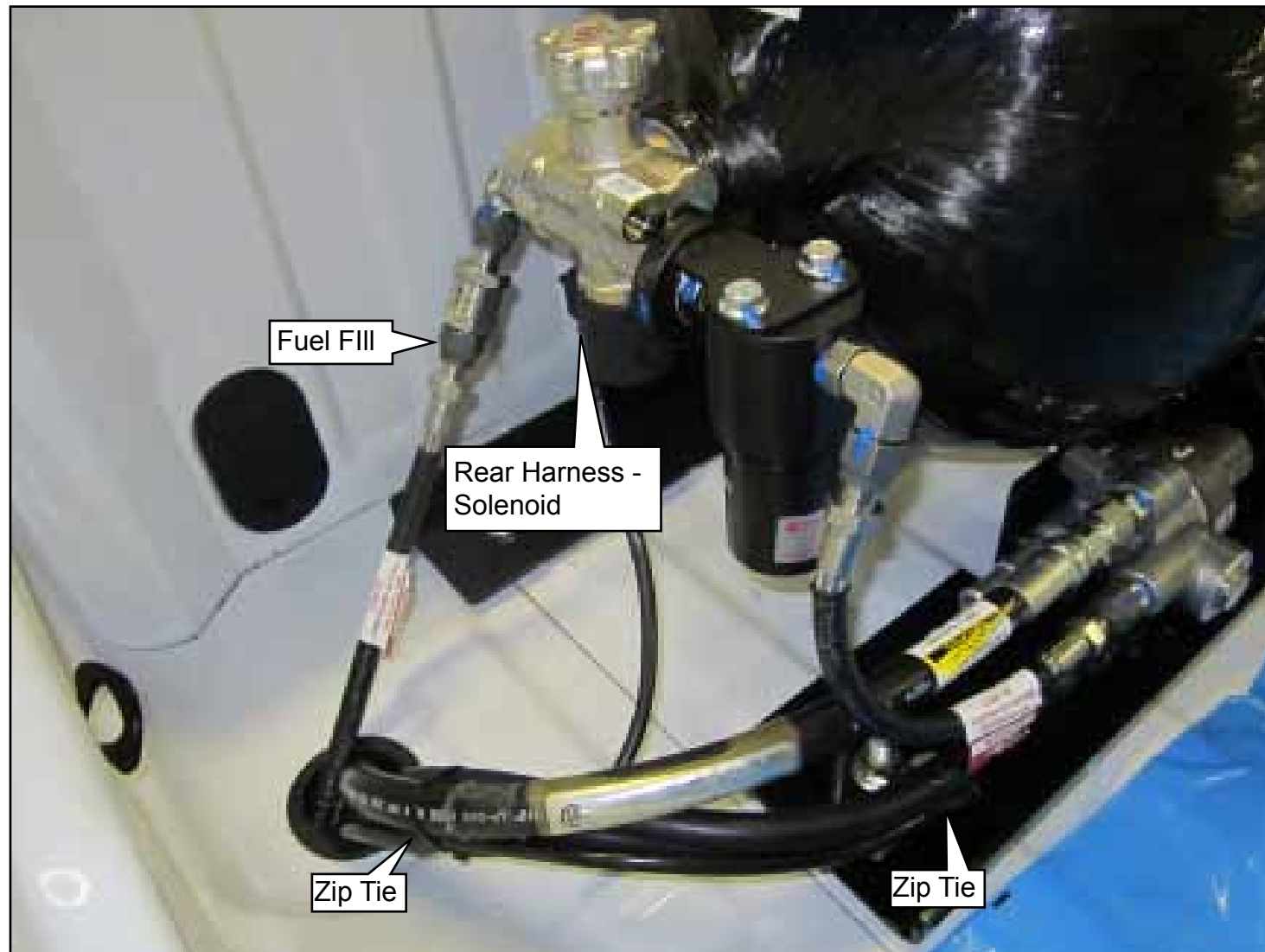

COOLANT HOSES, REAR WIRE HARNESS, LOW PRESSURE HOSE AND FUEL FILL CONNECTION TO CYLINDER PACKAGE

MAKING THE CONNECTIONS - 15.7, 21.2 GGE Package

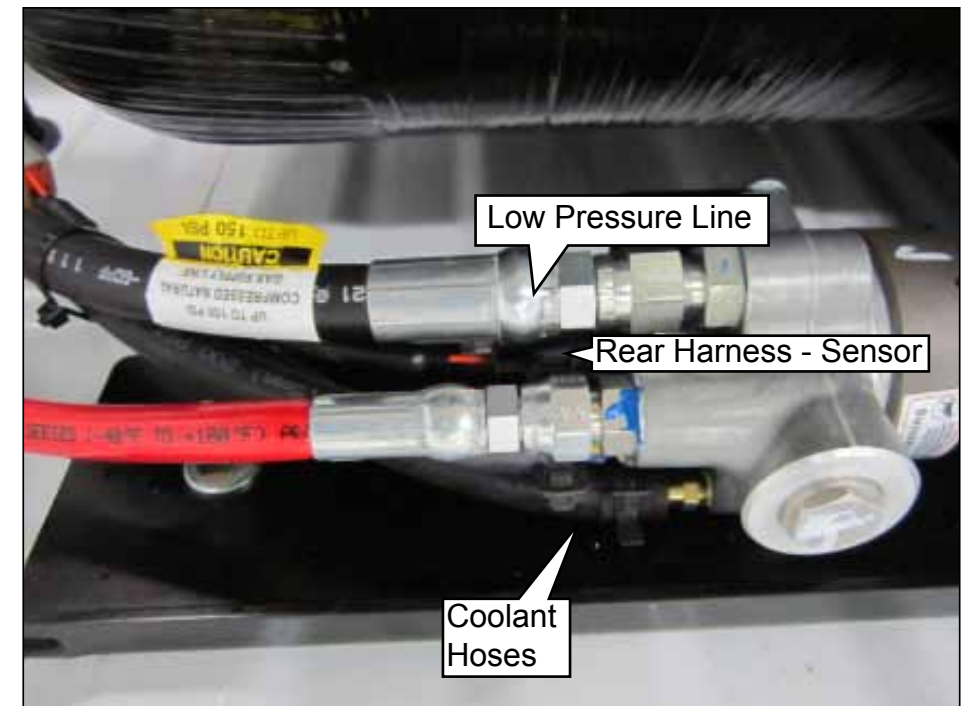

LOW PRESSURE HOSE, REAR WIRE HARNESS AND COOLANT HOSES ROUTING

Low Pressure Hose Routing

1. Begin at the bed of the truck, run the low pressure hose (MPH156) along the given path along the upper outside driver side frame and into the engine bay. Adjust length as needed to avoid hose slack.
2. Using a 15/16" p-clamp (PC15/16), secure the hose starting from the rear of the vehicle as depicted in picture #1. Note: The coolant hose p-clamp (1 1/8") and the low pressure 15/16" p-clamp will be secured together using one self tapping screw (135-H).
3. Continue to run the hose along the outer side of the frame. Ensure hose is ran over and inside of the frame support strut. Secure with another 15/16" p-clamp. **Refer to note below for special instructions.**
4. Continue and secure p-clamps in areas designated in picture #3. Secure on channel as depicted and use caution in order to avoid drilling into the cab floor.
5. Secure the hose on provided steel flap near the front frame support strut as shown in picture #5.
7. Verify the hose is not obstructed or loose. Verify that the hose runs below the wheel well and not over it. (hose may be ran before the fuel rail is installed.)
8. If CNG fuel rail and high pressure regulator has been installed, make the connection at each point and torque to 42 ft-lbs. Picture #6.

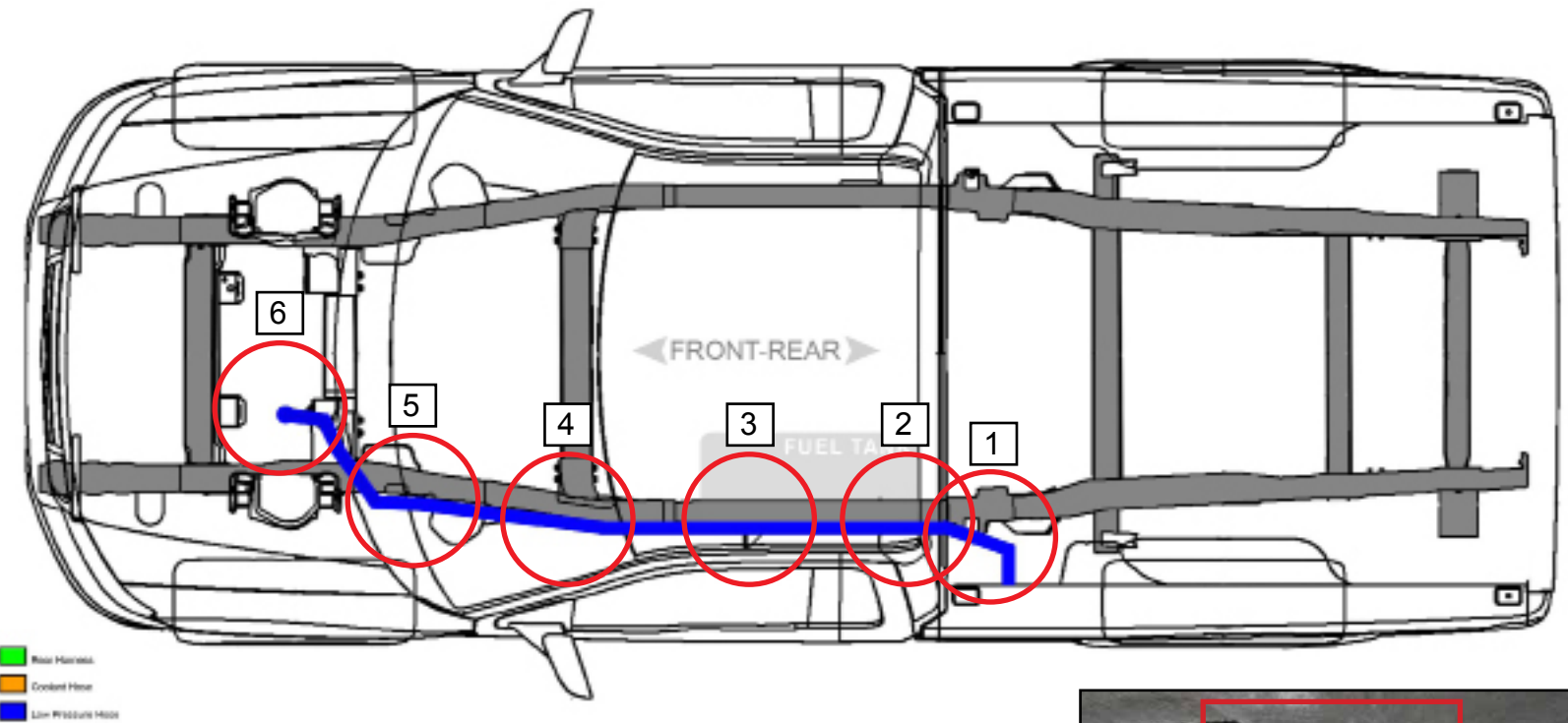

Refer to *COOLANT HOSES, REAR WIRE HARNESS, LOW PRESSURE HOSE AND FUEL FILL CONNECTION TO CYLINDER PACKAGE* page for additional connection information.

Secure to side of the channel.
Securing at bottom center may damage OEM harness located within the channel.

P-CLAMP



DO NOT secure in location shown.
Secure p-clamps to the sides of the marked area only.



LOW PRESSURE HOSE, REAR WIRE HARNESS AND COOLANT HOSES ROUTING

Coolant Hoses Routing

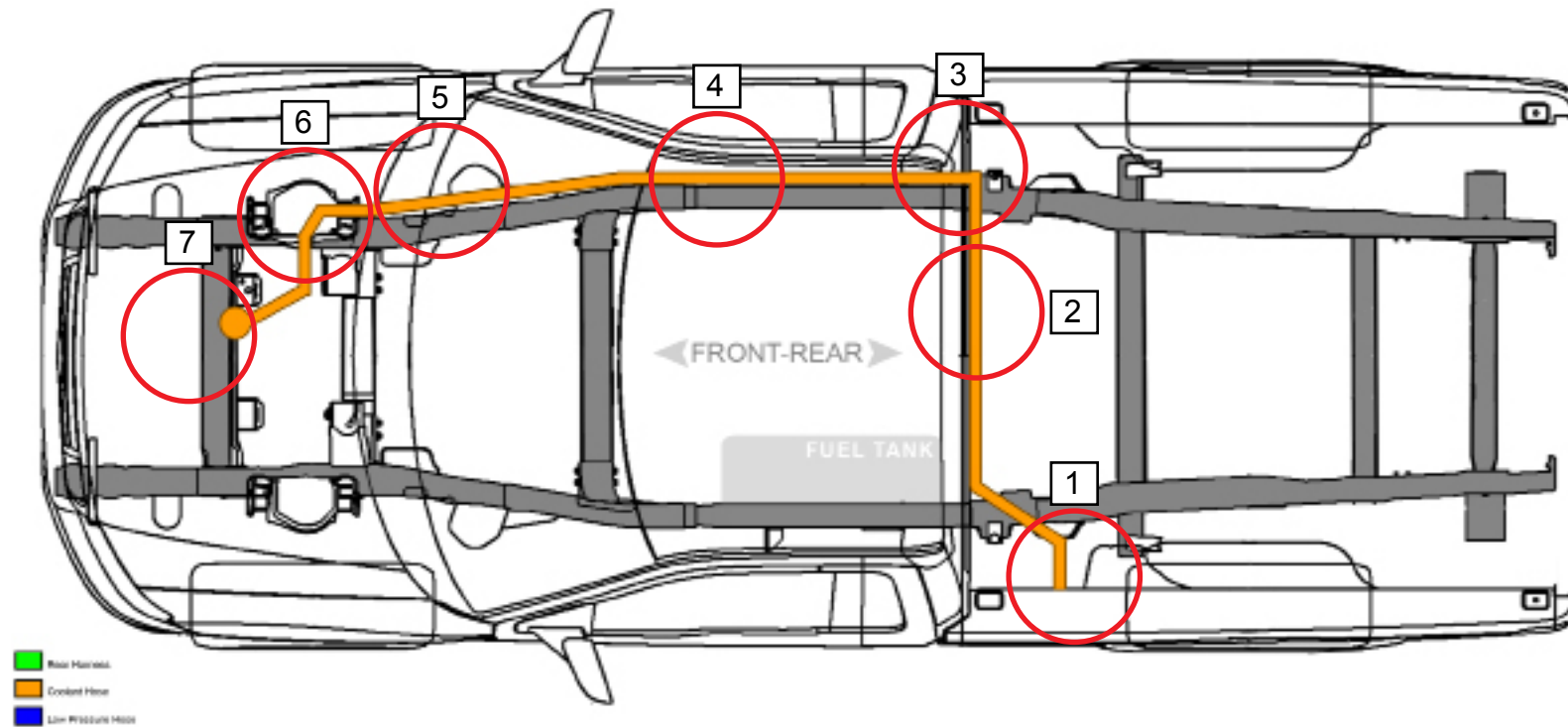

P-CLAMP



Refer to *COOLANT HOSES, REAR WIRE HARNESS, LOW PRESSURE HOSE AND FUEL FILL CONNECTION TO CYLINDER PACKAGE* page for additional connection information.

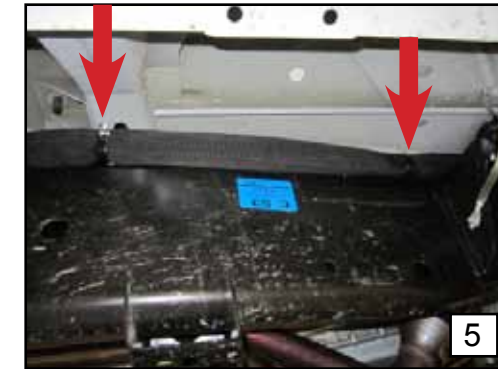
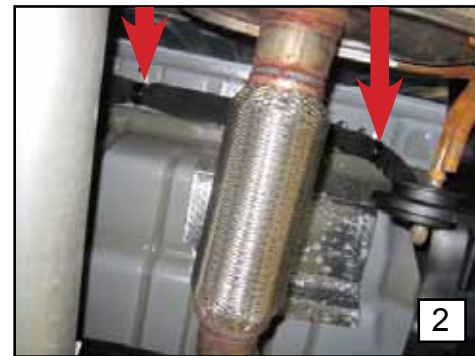

COOLANT HOSES, REAR WIRE HARNESS AND LOW PRESSURE HOSE ROUTING

Coolant Hoses Routing

Note: Be sure that Heat Shield sleeve is on and secured before installation. Feed coolant behind the front mount towards the engine. Heat shield sleeve should start right after the mount.

1. Starting at the rear of the vehicle, run the coolant hose to the front of the vehicle. Verify the hose length reaches both connection points comfortable before securing. A hose trim may be necessary.

Note: Kit Coolant hoses (CH-B-H) are pre assembled with flex guard and heat shield.

2. Begin securing the coolant hose from the rear of the vehicle. Use a 1 1/8" p-clamp (PC1 1/8). The low pressure hose and coolant hose p-clamps will be secured using one self tapper screw (135-H).
3. Run the hose below the under cab across to the other side and secure at the two points shown in picture #2.
4. The coolant hoses will curve around and continue over the top outer part of the frame shown in picture #3.
5. Run hoses behind the frame mount and secure as shown in picture #4.
6. Continue running the hoses and secure as shown in picture #5.
7. Run the hoses behind the frame mount and into the engine bay.
8. Inside the engine bay, secure the hoses to the existing stud on firewall with p-clamp and use (191) nylock flanged nut to secure.
9. Working on one hose at a time, clamp two sides of the OEM coolant hose to suspend coolant flow. Cut into the hose. Cut away about 3/4" out of the OEM coolant hose to accommodate the coolant Y space. Install and secure the coolant Y's with 3/4" hose clamp (HC8-PF) on the OEM side and with 17mm hose clamp (HC17MM) on the kit hoses side.

Note: The kit side of the coolant Y must be positioned facing **down**. Refer to diagram for illustration.

10. Connect the coolant hoses to the regulator on the bed of the truck. Use 17mm hose clamps to secure.
11. Make sure to replenish the cooling system after the CNG system is complete. Always use the Ford recommended type of approved and compatible coolant.

Installation will vary in quantity of cable ties or P-Clamps depending on cab and bed size.

Refer to *COOLANT HOSES, REAR WIRE HARNESS, LOW PRESSURE HOSE AND FUEL FILL CONNECTION TO CYLINDER PACKAGE* page for additional connection information.

The AlTech-ECO regulator requires engine coolant be used to maintain a consistent temperature for proper CNG fuel system operation. The OEM coolant hoses (heater hoses) in the engine compartment are used to obtain the coolant necessary for regulator operation. Y-connectors and clamps are used for coolant hose connection. If the coolant hoses have not been installed yet, refer to *INSTALLING THE FUEL LINES, COOLANT HOSES AND REAR ELECTRICAL HARNESS* for the procedure.

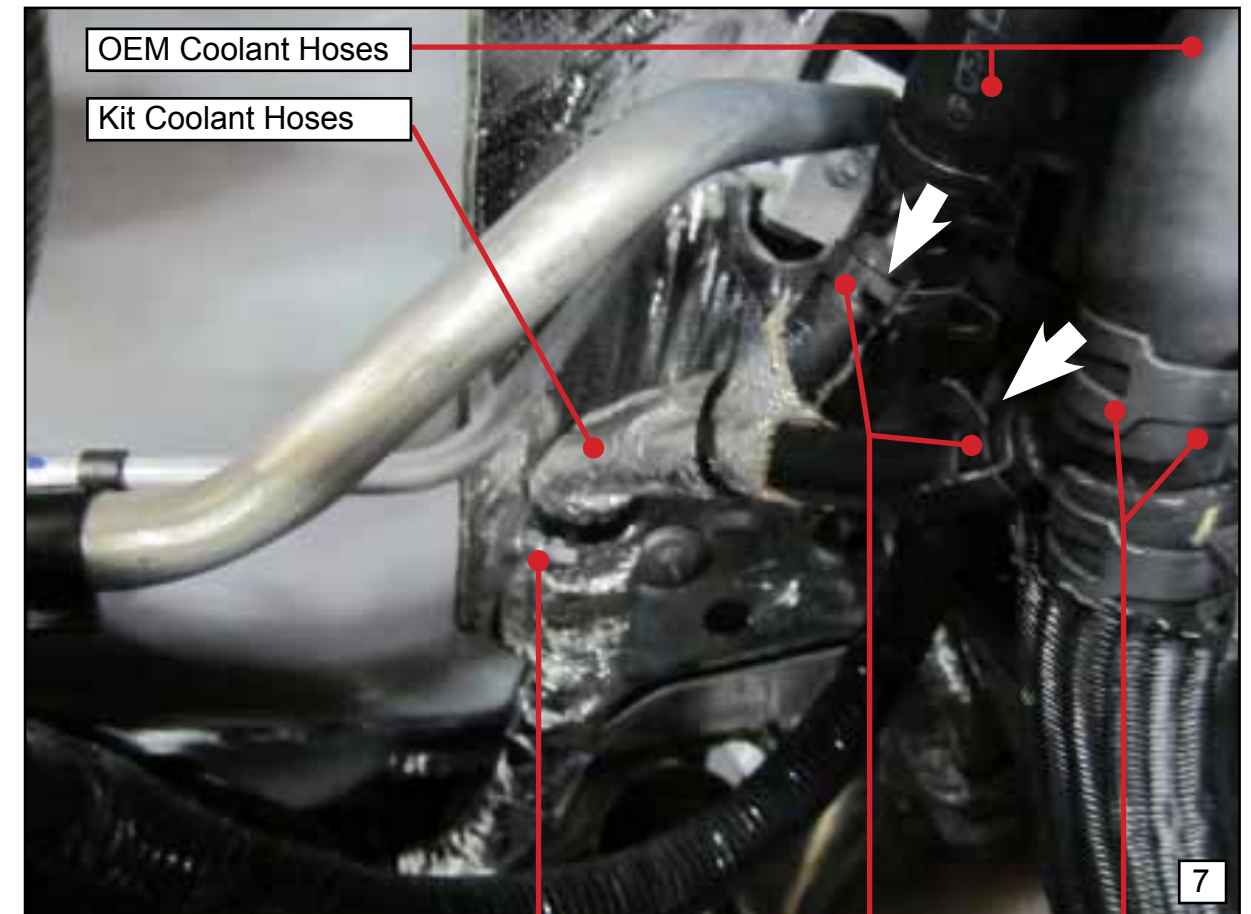

1 1/8" hose clamp with M6 flanged nut used to secure kit coolant hoses to existing stud

17mm hose clamps used to secure coolant Y's to kit coolant hoses

3/4" hose clamps used to secure coolant hoses and coolant Y's together

COOLANT HOSES, REAR WIRE HARNESS AND LOW PRESSURE HOSE ROUTING

Rear Harness Routing

Note: Always check to be clear of any exhaust or suspension parts that can damage the CNG components. Avoid securing the rear harness to any OEM fuel lines or hoses.

1. Beginning from under the vehicle, run the rear harness from rear to front following the OEM wire harness on the frame. Run the solenoid plug through the 2 1/8" grommet located in the bed. Verify the each end reaches each connection point comfortably.
2. Secure the rear harness to the OEM wire harness using 7 1/2" zip ties (CT-7.5-A). Secure the Rear harness every 1-1 1/2 ft and mainly at the curve points and avoid any slack in the harness.
3. Continue running the harness into the engine bay. Secure the harness to engine block at the shown point using a christmas tree zip tie (CTPM8). Refer to picture #4. Connect the rear harness to the main CNG wire harness (if the main CNG wire harness has been already installed).
4. Snip all zip tie ends properly to avoid injury.
5. If a CNG wire harness and a high pressure package has been installed, make the necessary connection. Rear harness to CNG main harness and other end to the valve solenoid.

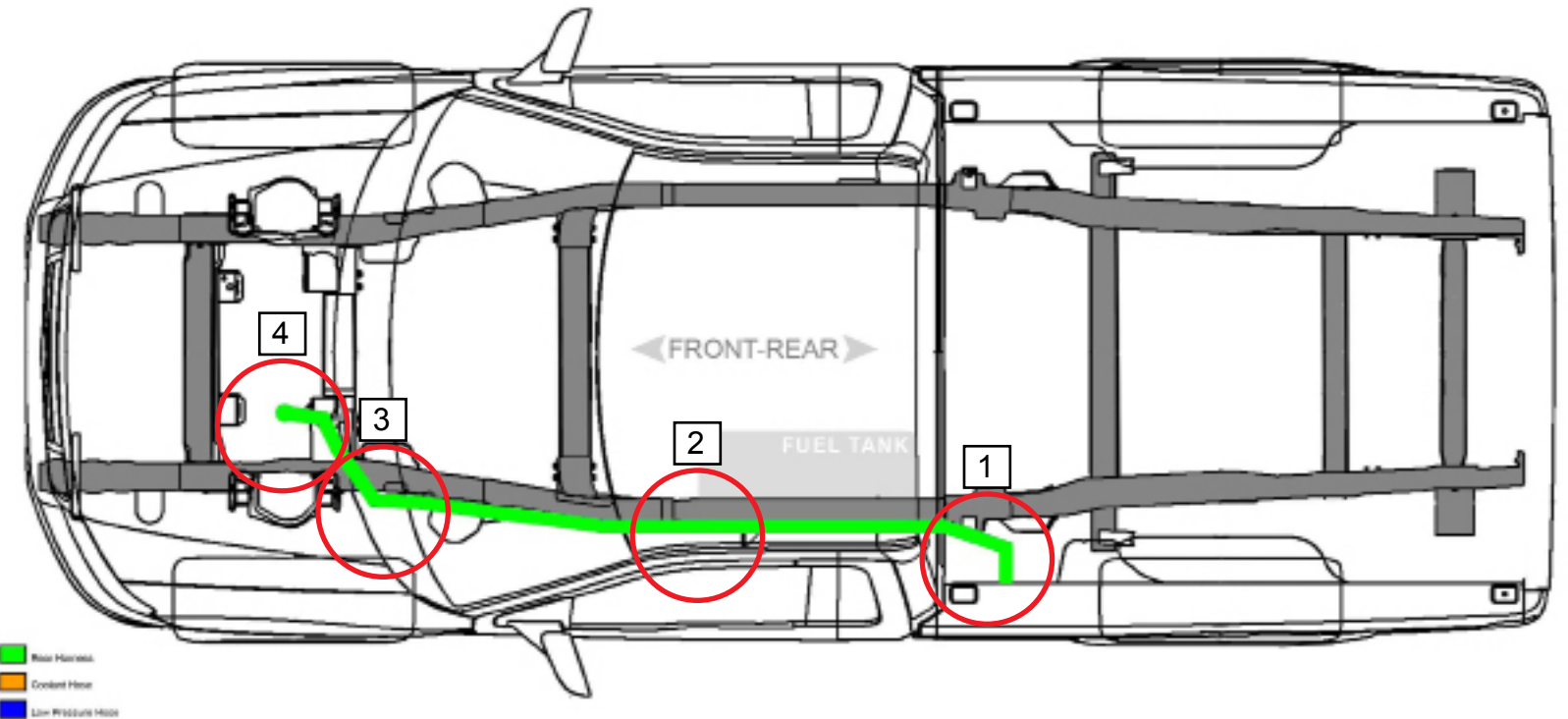

Refer to *COOLANT HOSES, REAR WIRE HARNESS, LOW PRESSURE HOSE AND FUEL FILL CONNECTION TO CYLINDER PACKAGE* page for additional connection information.

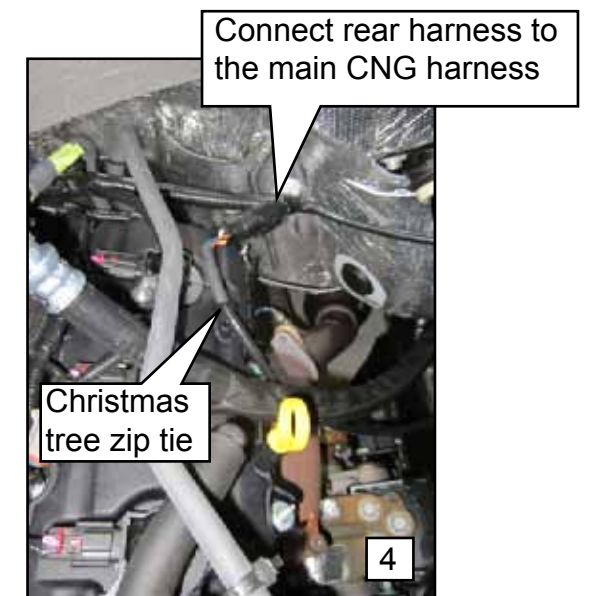
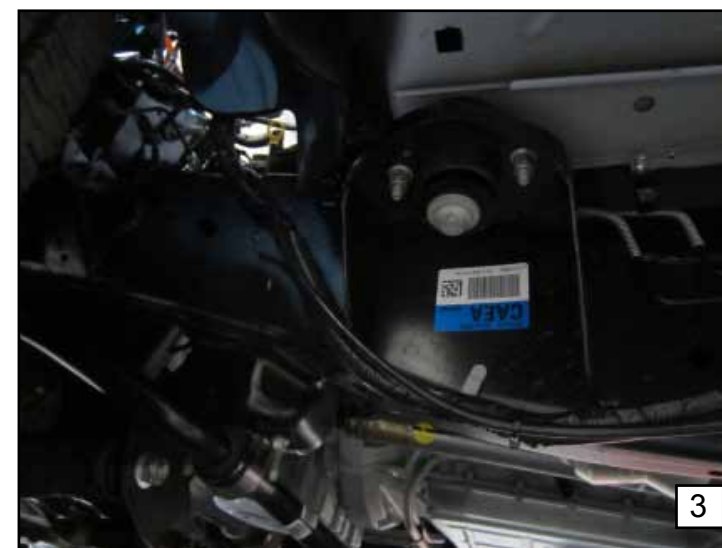

INSTALLING THE BI-FUEL SYSTEM COMPONENTS ON ENGINE

Engine Disconnect Points

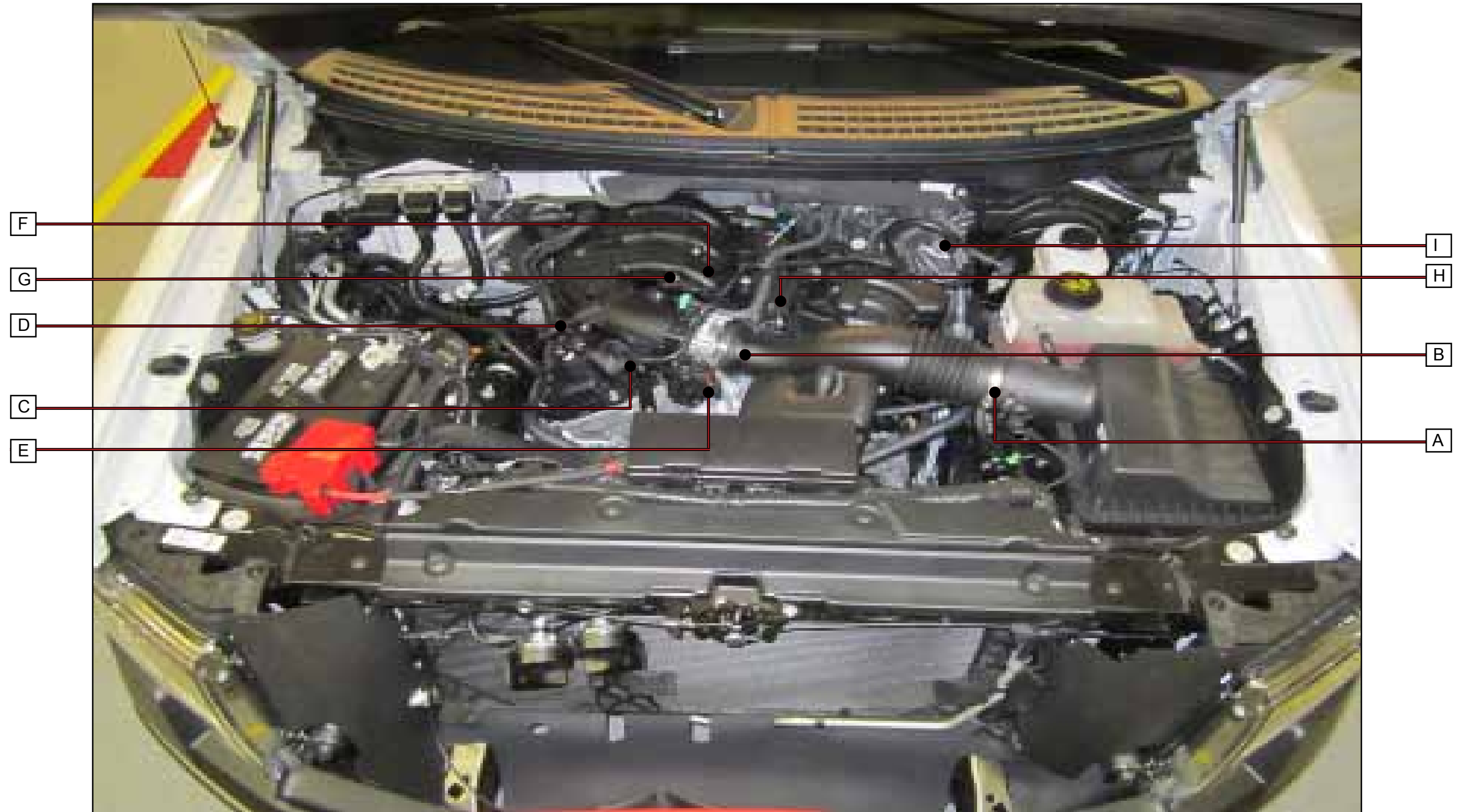

INSTALLING THE BI-FUEL SYSTEM COMPONENTS ON ENGINE

Remove or Disconnect OEM Components to Access Engine

There are two AiTech-ECO compressed natural gas (CNG) fuel systems that can be installed on the Ford F-150. The bi-fuel system, which allows the vehicle engine to run on either gasoline or CNG, or the dedicated fuel system, which when installed, only allows the vehicle engine to run on CNG. Either of these systems applies to all vehicle configurations.

Some original parts may be reused or will remain in place after the installation of the CNG system. The components in this section may be saved, discarded or new.

Tools:

- Basic Hand Tools

Note: The CNG fuel rail and adaptor plate will be pre-assembled.

WARNING: DO NOT USE POWER TOOLS.

1. Begin with loosening the clamps around the air box.
2. Disconnect all hoses and plug connections connected to the intake and air box. Refer to pictures shown for the connection points to be disconnected.

Note: Refer to the next page for the disconnect points.

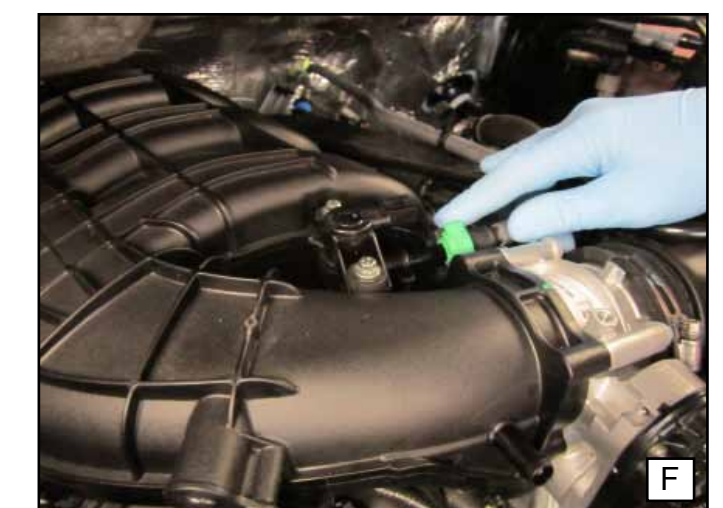

INSTALLING THE BI-FUEL SYSTEM COMPONENTS ON ENGINE Continued

3. Remove the air box and set aside clear of any debris.
4. Remove and discard the bracket connecting intake to engine block. Refer to picture #2. Re-install the bracket bolts only.
5. Loosen all 7 intake bolts.
6. Remove the intake. Make sure to keep the intake location on the engine clear of any debris.
7. Once the intake has been removed, remove bolts from intake. Leave the bolt tube spacers in place.

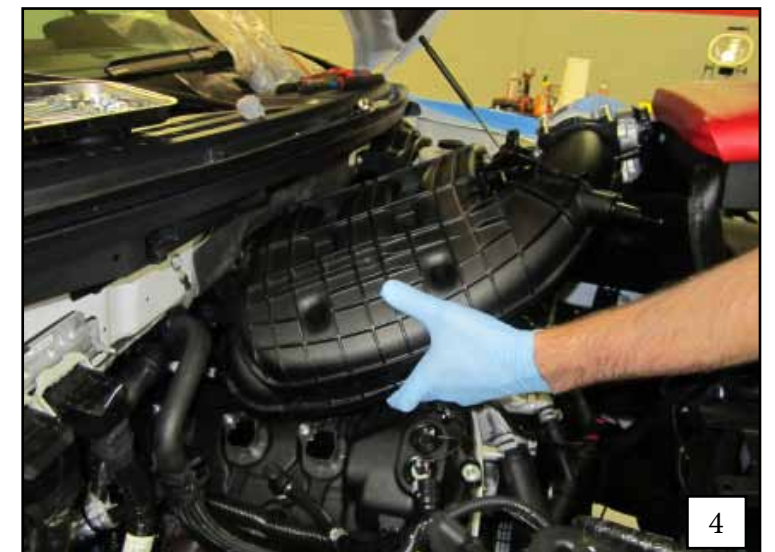
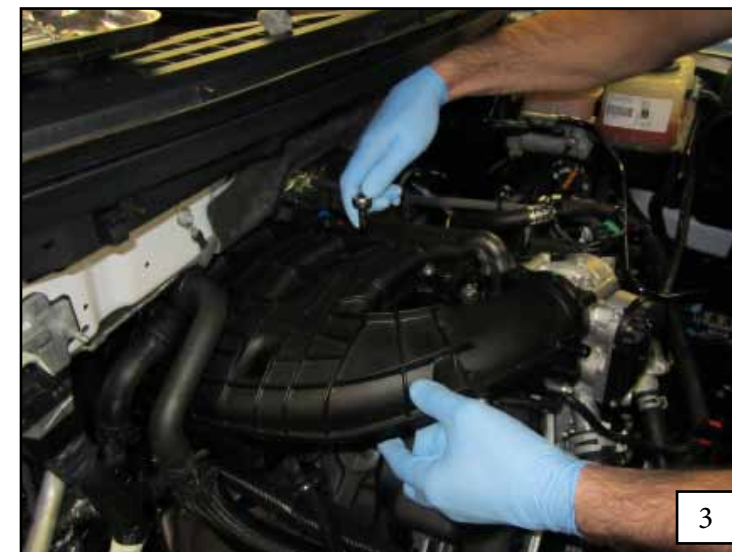

INSTALLING THE BI-FUEL SYSTEM COMPONENTS ON ENGINE Continued
Installing the CNG fuel rail and adaptor assembly

8. Obtain the CNG fuel rail adaptor assembly. Do not loosen or remove any of the components from the assembly. This assembly has been checked for quality and leak tested prior to being released.
9. Install the fuel rail assembly unto vehicle engine. Align with head block runners.
10. Install intake over the the fuel rail adaptor assembly. Hand start all seven bolts then tighten to 89 in-lb in order shown.
11. Connect the low pressure hose to the fuel rail if it has not yet been connected. The CNG low pressure hose goes over the OEM hose. Picture #10.
12. Connect low pressure sensor if the CNG main harness is installed. Picture #12.
13. Re-install the air box assembly.
14. Reconnect all OEM hoses and plugs. Refer to engine disconnect diagram for re-connection points.

① 140mm Bolt

Fastener Bolt Tightening Order

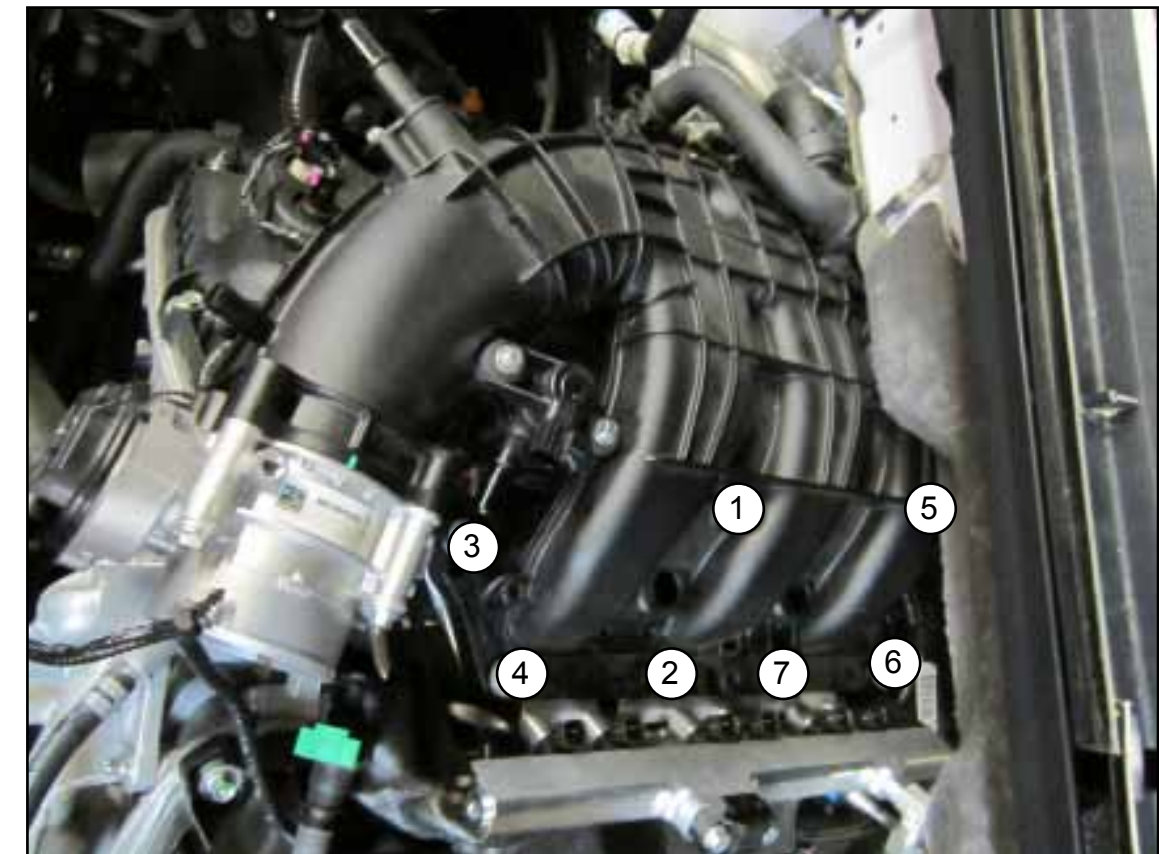

CNG Fuel Rail Adaptor Assembly

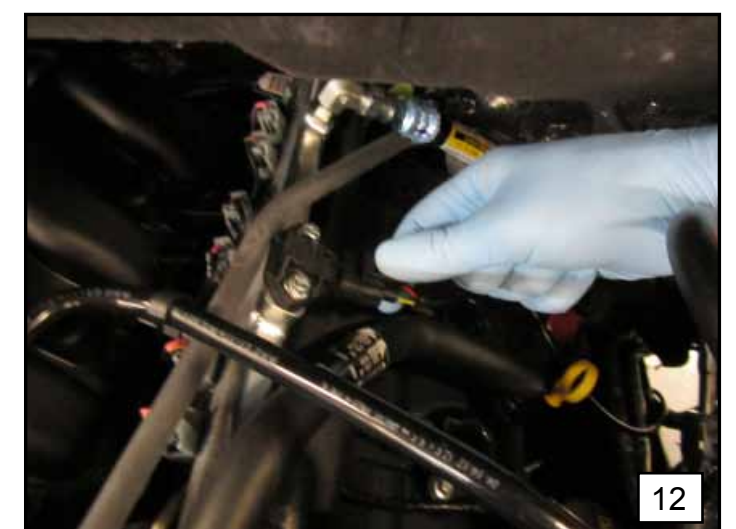
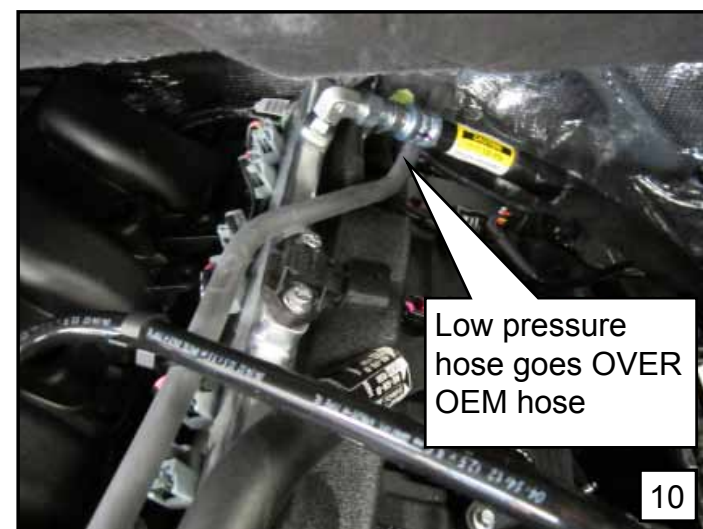
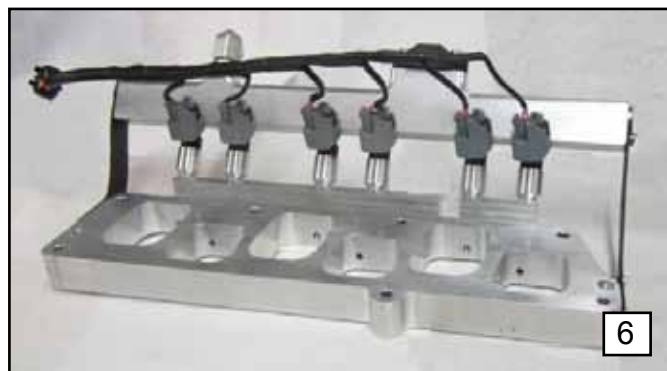

INSTALLING THE BI-FUEL SYSTEM COMPONENTS ON ENGINE Continued
Installing the CNG fuel rail and adaptor assembly

15. Replace OEM manifold support bracket with the new kit manifold support bracket (F1MSB-3.7). Secure using existing OEM support bracket bolts.

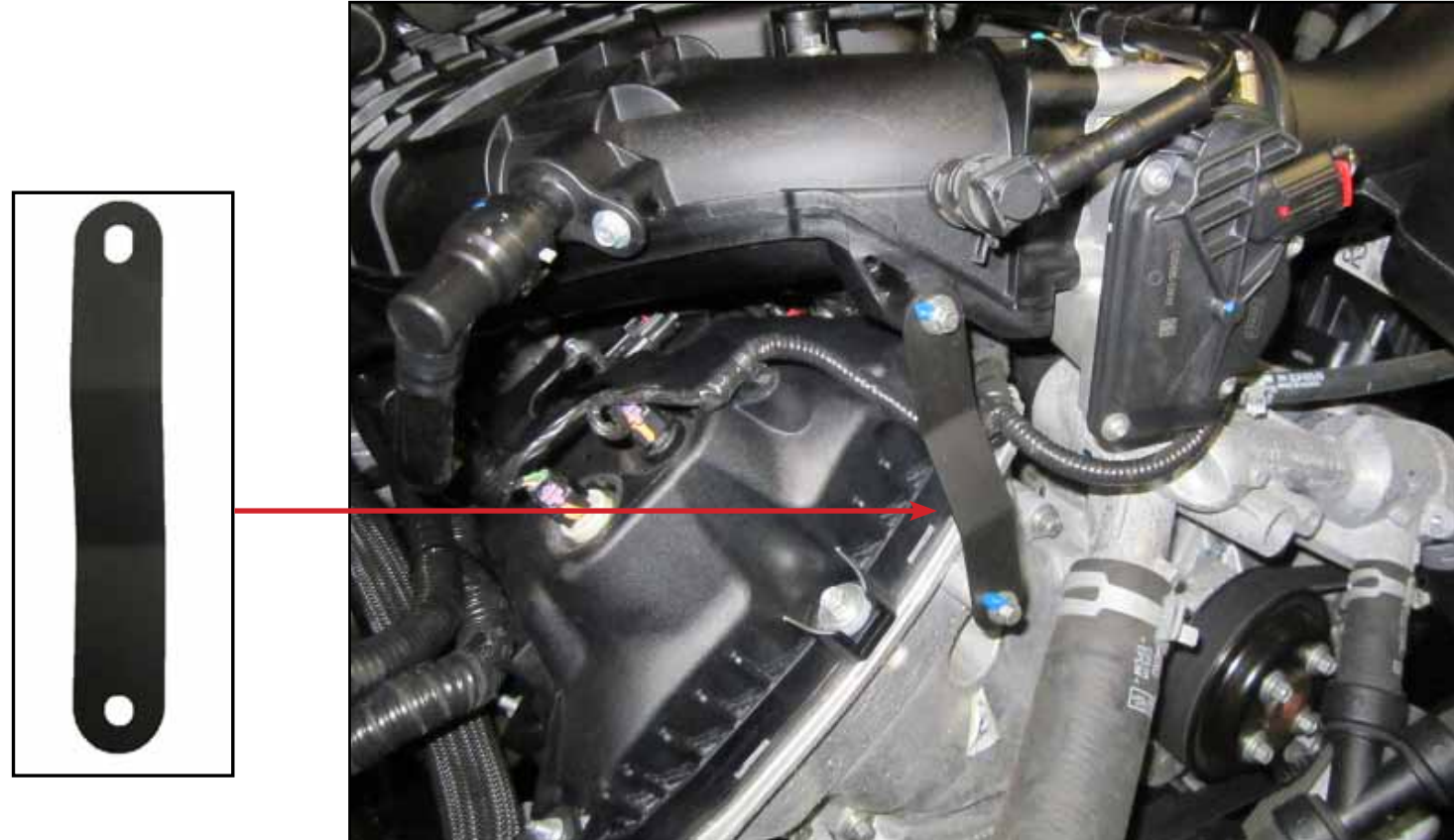

INSTALLING THE MAIN WIRING HARNESS

Installing the harness and diagrams

Installing the main wiring harness is essentially the same for all vehicle models. The main wiring harness is installed in the engine compartment and provides take-out connections for the components attached to the harness. Refer to provided wire harness diagrams) :

- AITech-ECO alternate fuel control module (AFCM) connectors
- AITech-ECO fuse and relay panel (hard wired into main harness)
- Positive and negative leads (connect to vehicle battery)
- Three lead harness to controller area network (CAN) bus (connect into Ford powertrain control module (PCM) harness)
- Temperature pressure sensor (TPS) connector
- Fuel injector wiring harnesses (bi-fuel system)
- 10-pin connector for rear electrical harness
- 6-pin connector for the fuel gauge and bi-fuel selector (switch) if equipped.

Other components are the AITech-Eco AFCM and the AFCM mounting bracket.

Tools:

- Basic Hand Tools

1. Obtain the main CNG wire harness (F150-3.7AFCM-BI-WH)
2. Begin by layout out the harness starting at the battery terminals. Refer to wire diagram template. When routing to (-) terminal, fit the (-) of the CNG wire harness plug through the OEM loop located around the OEM (-) terminal (picture #1).

Note: The routing path of the CNG wire harness should be similar to the OEM main wire harness path.

3. Attach (+) part of the CNG main harness to OEM (+) battery terminal connection. Secure with a 7 1/2" zip tie (CT-7.5-A). Picture #2.
4. Zip tie CNG main harness to OEM harness as shown. Picture #4.
5. Leave CAN bus plug loose and away from the inner fender. Picture #5.

Vehicle battery must be disconnected during this portion of the installation

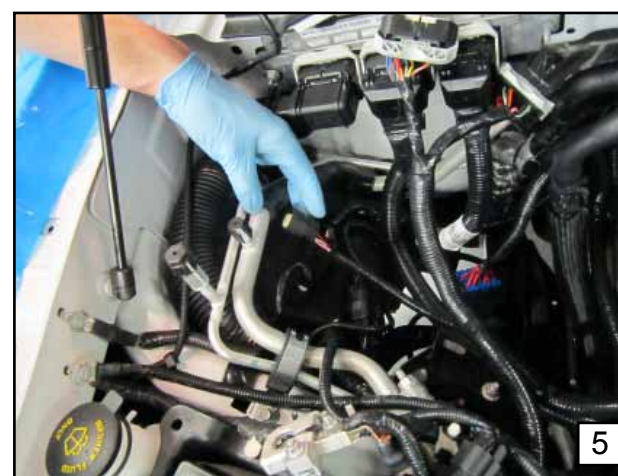
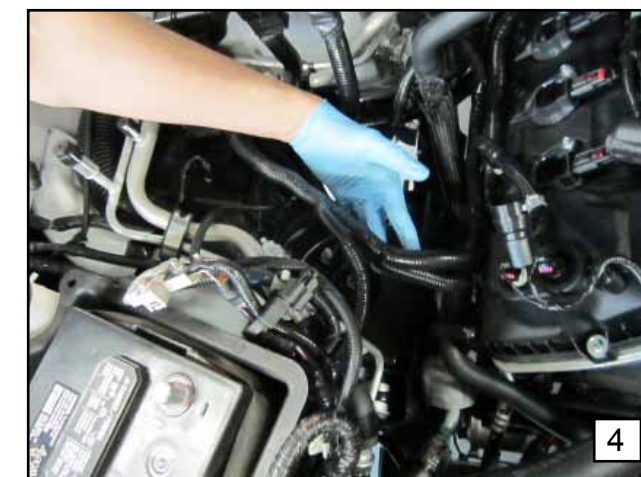

Installing the harness and diagrams continued...

6. Zip tie the CNG main harness to the OEM main harness right before the distribution box wire branch.
7. Secure distribution box. To secure the distribution box, use the PDB bracket (45998) as a template. Measure 1 1/4" from the edge of wiper cowl and 1/4" from the PCM. The PDB bracket must be leveled. Picture #1.
8. Secure the PDB bracket with 3/4" self tapping screws (136-H). Picture #2.
9. PDB wire branch must be ran in between the two OEM coolant hoses. Picture #3.
10. Place the distribution box onto the PDB bracket. Picture #4.
11. Continue securing the CNG wire harness behind the very back center of the manifold. (This can be done with or without the manifold in place). Picture #5.
12. Remaining main harness connectors will stay loose until each of the harnesses (Interceptor harness, Switch gauge harness, rear harness) has been installed. Make the necessary connection between harnesses if they are installed.

Note: You may connect any previously installed harnesses to the CNG main wire harness as you install the main harness.

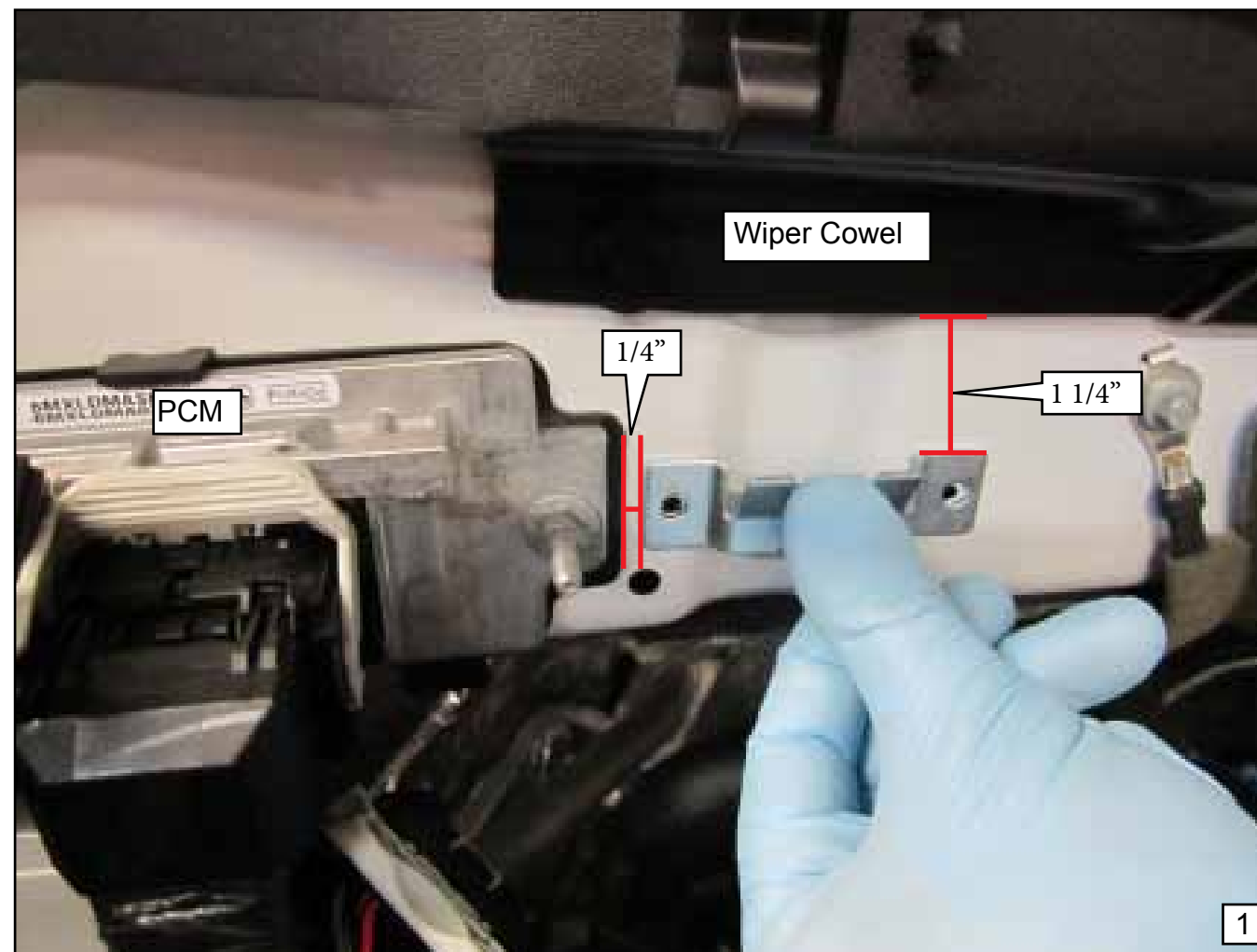



Note: You may connect any previously installed harnesses to the CNG main wire harness as you install the main harness.

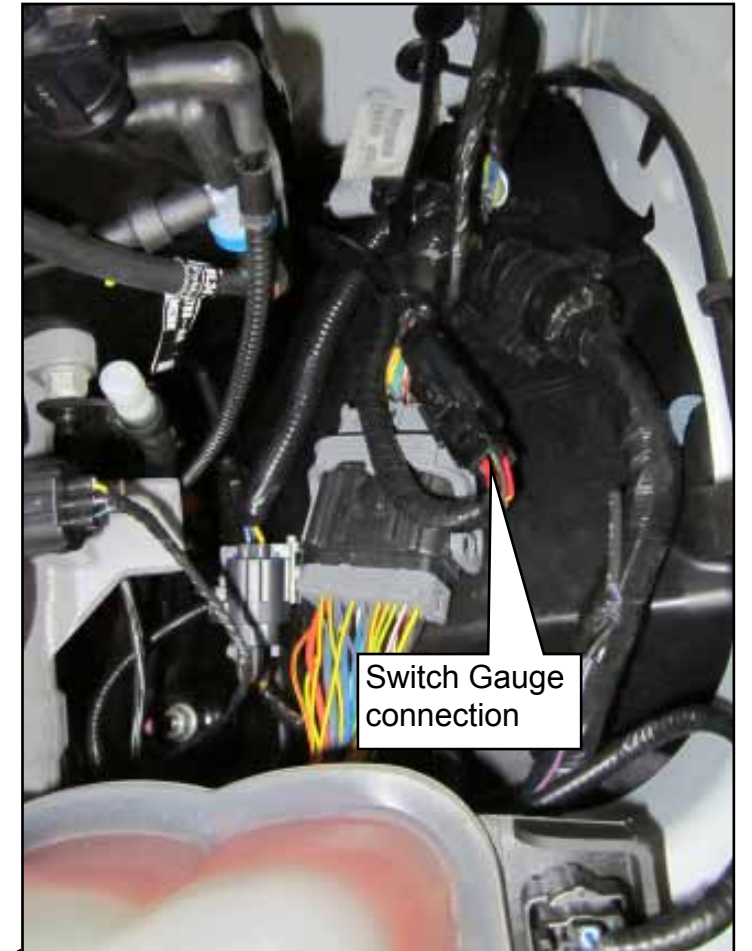

BI-FUEL HARNESS DIAGRAMS
Main CNG Wire Harness Routing



BI-FUEL CNG MAIN WIRE HARNESS

CNG MAIN HARNESS: F-150-3.7AFCM-Bi-WH

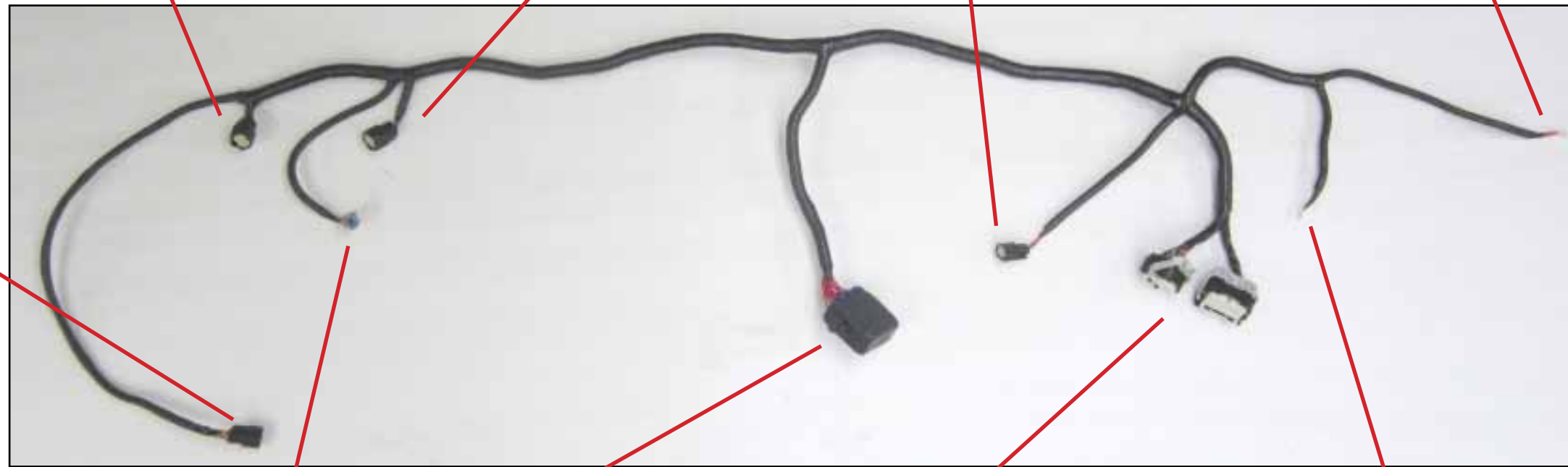

F-1503.7MHD-D-Bi

REAR , SWITCH/GAUGE, INJECTOR HARNESS

REAR HARNESS:
F-150-3.7AFCM-RWH-B13.5-V

5/8" GROMMET

TO TRANSDUCER



TO SOLENOID



TO MAIN CNG HARNESS

SWITCH/GAUGE HARNESS:
F-150-3.7BISWGA

TO CNG MAIN HARNESS



TO SWITCH



TO GAUGE

Bi-FUEL INJECTOR HARNESS: F-150-3.7INJWH



TO INJECTORS



TO CNG MAIN HARNESS

F-1503.7MHD-D-Bi

INSTALLING AFCM AND BRACKET

Underhood AFCM installation

AFCM: Alternate Fuel Control Module

1. Remove PCM nut located on the furthest left side of the PCM (passenger side). Picture #1.
2. Install u-nuts (111) unto AFCM bracket. Picture #2.
3. Install AFCM (150AFCMBR-6.2) bracket using the same studs as the PCM. To secure the bracket, for the left side use existing OEM nut, for the right side use kit bolt (191). Picture #3.
4. Install AFCM and secure using 3/4" bolts (175-H). Picture #5.
5. Plug in CNG wire harness into plug A and B on the AFCM. Picture #5.

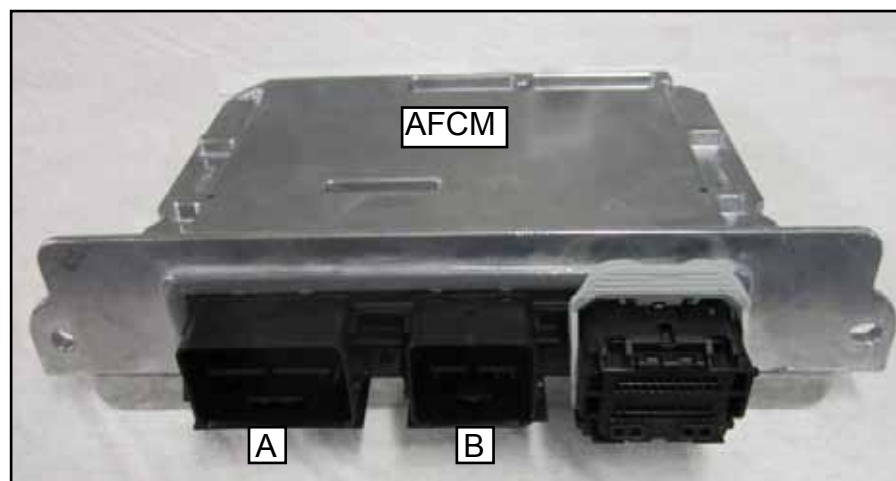
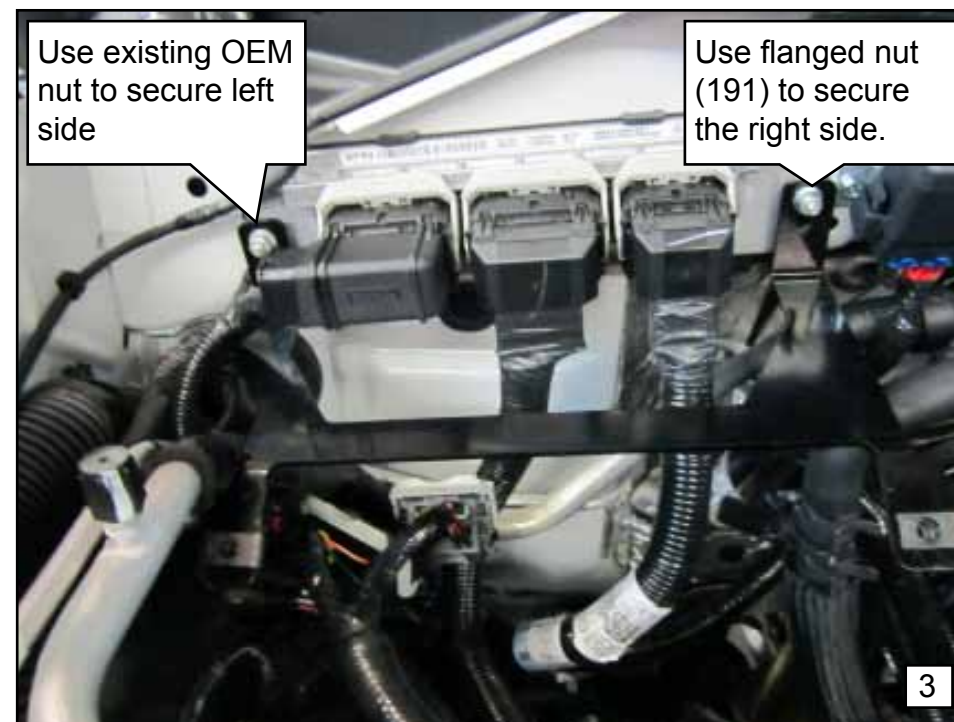
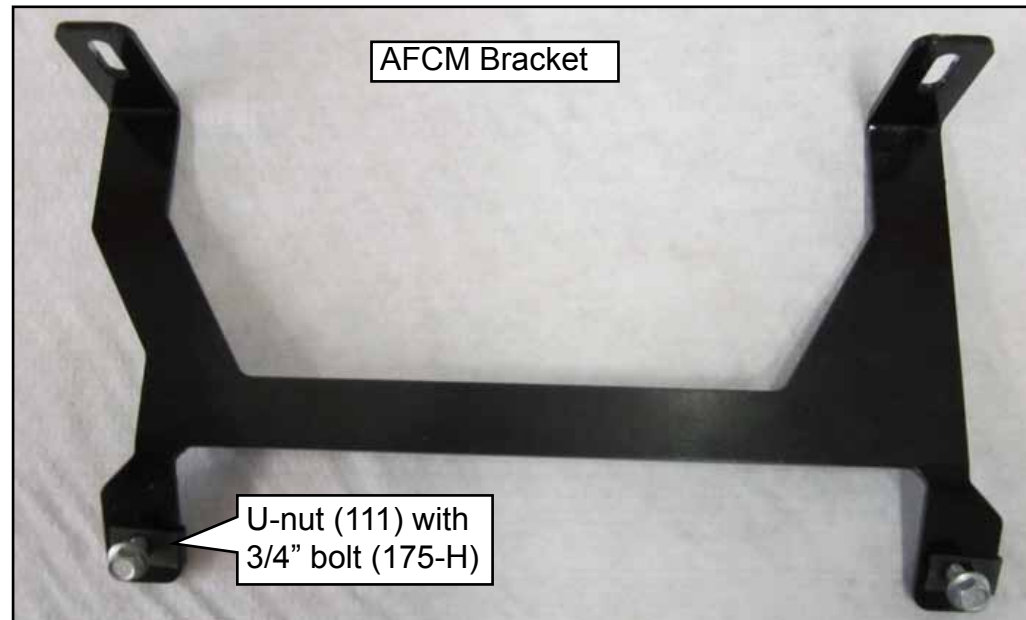

INSTALLING THE PIG TAIL CAN BUS

Make the CAN Bus Connection

- 1-2. Locate the FORD PCM on the passenger side of the engine compartment. Remove the dust shield which is held on by two flat clips. Remove the dust shield and set aside.
- 3-4. Find the largest connector on the FORD PCM plug "A" (Closest to the fender). Pull back the latch to unplug.
5. Remove the protective cover from the FORD PCM connector "A". peel back the electrical tap and the loom. This will insure easy access for striping and soldering the wires.

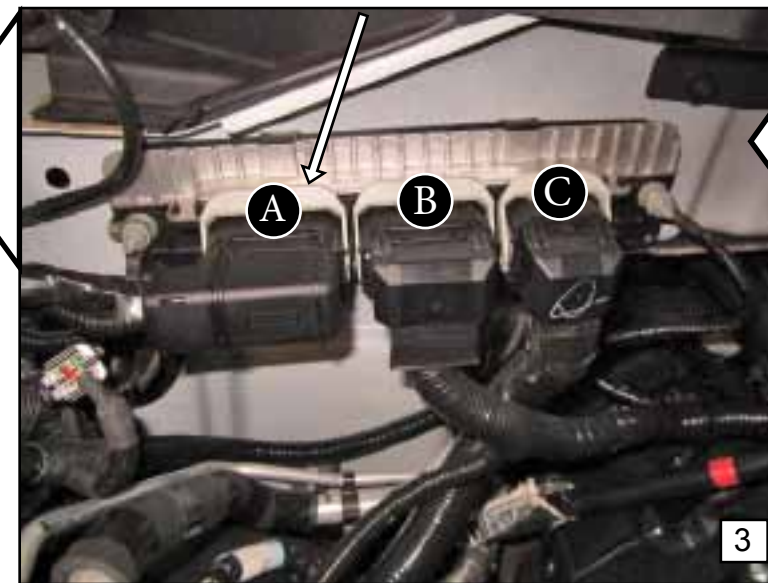

INSTALLING THE PIG TAIL CAN BUS

Make the CAN Bus Connection

Note: It is recommended to de-pin the wire that you are working on for a cleaner installation. Also, de-pin the three wires one at a time to prevent cross-wiring or incorrect connections. Locate the "Rear harness and Pin out" sheet from your kit to continue.

6. Locate pin number A67, A59 and A58 on the connector.
7. De-pin the first wire and proceed to strip the wire about an inch leaving insulation on both sides.
8. Solder the CAN bus wire onto the Ford wire. Let cool then inspect for a good connection. slide the heat shrink onto the exposed wire and heat to finish.
9. Follow the steps 6-8 for the other two wires.
10. Once all three wires have been finished reassemble the FORD connector and plug it back into the FORD PCM. Reattach the dust shield and secure it. Finally plug the CAN bus harness into the CNG MAIN WIRING HARNESS.

Continue to the fuse box (power distribution box) installation.



CAN bus harness

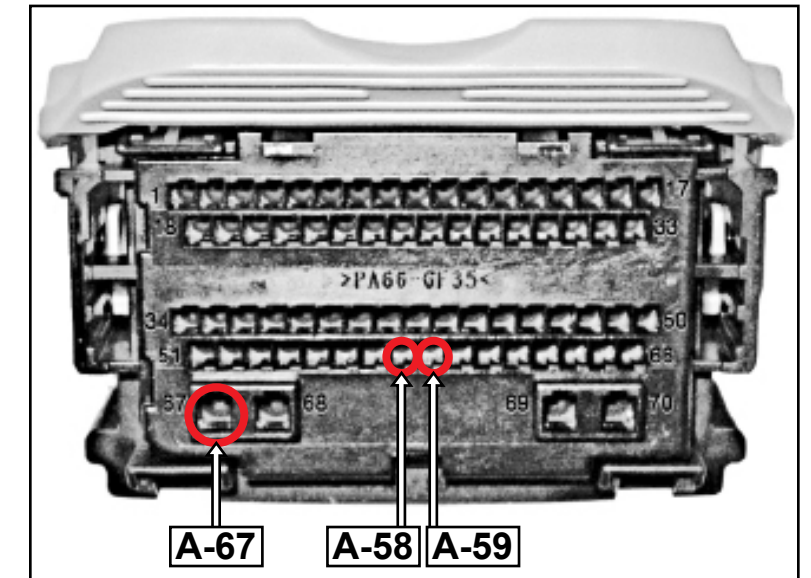

INSTALLING THE BI-FUEL SELECTOR AND CNG FUEL GAUGE

Installing Bi-Fuel Selector Switch/Gauge harness

The bi-fuel selector and fuel gauge harness is (F150-BISWGA).
The fuel gauge harness for the dedicated system is (F150-DEDGA).

A rectangular hole must be cut into the dimmer switch panel to accommodate the selector.
See example 1

CAUTION: During this step you will be drilling thru the firewall. Always check both sides of the drill location before proceeding as not to cause any damage.

1. From the engine compartment mark and predrill a pilot hole into the firewall. Then use a unibit to open the hole to 3/4" to allow the harness to be pulled thru.
2. From the inside cut out a hole in the insulation to match the hole in the firewall.
3. Push the wire thru the hole. Be sure to run the switch harness to the dimmer panel (on Bi-fuel only).
4. For switch panel cutting wiring refer to **INSTALLING Bi-Fuel Selector Switch**.
5. Start routing the gauge wire. Remove the bottom piece if the center cluster.
6. Route gauge harness to where the 12V plug was. For instructions on removal and assembly refer to **INSTALLING Gauge**.



INSTALLING THE BI-FUEL SELECTOR AND CNG FUEL GAUGE

Installing Bi-Fuel Selector and Electrical Wire Harness

The bi-fuel selector or switch is required on vehicles when the bi-fuel system is being installed. Dedicated CNG fuel systems do not require this selector. The bi-fuel selector switch is (AFCMBI-SWITCH).

A rectangular hole must be cut into the dimmer switch panel to accommodate the selector. See example 1

CAUTION: A precision cut **MUST** be made to protect the dimmer switch panel from damage and to ensure a precise fit of the selector switch.

1. Carefully remove the dimmer switch panel. Unplug and take to work station.
2. Use a dremel tool or another precision cut tool to make the cut shown in example 1.
3. Once the cut has been made clean off any excess shavings and make sure the CNG switch fits. Make any adjustments to the cut if needed.
4. Then make the following connections to CNG switch (Example 2):
 - Pink wire to terminal 4
 - Brown/green to terminal 2
 - Brown/orange to terminal 3
 - Black to terminal 1
5. Finished CNG switch should look like this on the dimmer panel. Before replacing the panel be sure that all OEM and CNG connections are plugged in.

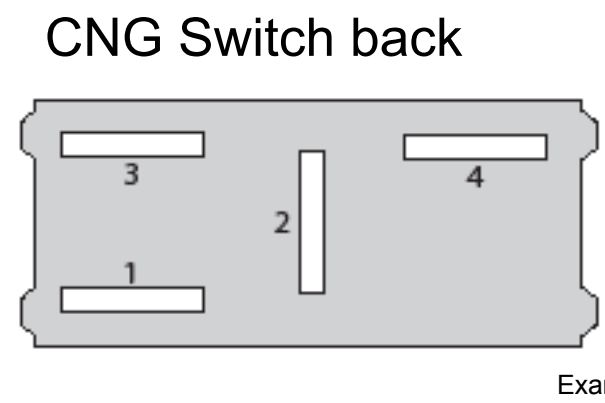
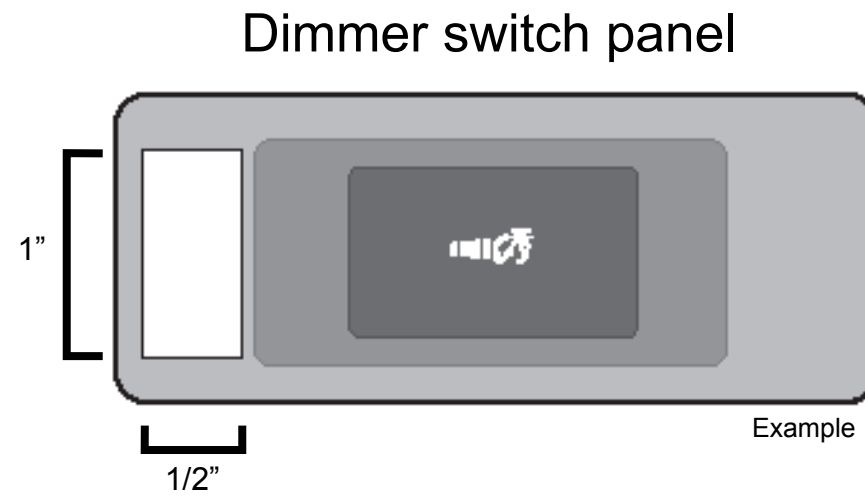

INSTALLING THE BI-FUEL SELECTOR AND CNG FUEL GAUGE

Installing Fuel Gauge

- 1-1a. Open glove box empty it then un-hook the sides to drop it all the way. look up to see three 8mm bolts. These bolts secure the airbag bracket. Remove airbag assembly just enough to access the bolt holding the trim piece.
2. Remove the 8mm bolt that holds trim in place.
3. Starting at the bottom of the right trim carefully pull out to unclip.
4. Once the bottom is unclipped, pull up on the center working your way up.
5. Remove trim from dash and unplug the 12V receptacle. For the next step remove the 12V assembly from trim. Continue on next page.

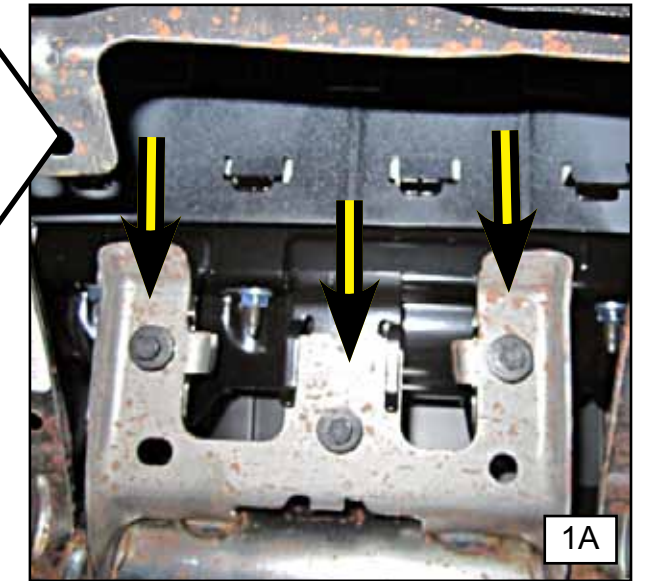

INSTALLING THE BI-FUEL SELECTOR AND CNG FUEL GAUGE

Installing Fuel Gauge

The fuel gauge is (AUTOMETERFUELGAUGE-CV).

CAUTION: When drilling the trim be sure to keep it steady as not to damage the finish.

1. Use a 2" hole saw to cut the trim piece to accommodate the CNG fuel gauge. Be sure it is even all the way around before cutting. Clean off any excess for a smooth finish. The final hole should look like this.
2. Remove the Fuel gauge from packaging and find the rubber O-ring in your kit. Slide O-ring onto the back of the gauge and work it to the front. The O-ring acts like a washer and will ensure a clean fit.
3. See the instructions in fuel gauge box for assembly of the bracket.
4. Then make the following connections to CNG Fuel gauge:
 - Single Red wire to "+12V"
 - Single Black wire to "GND"
 - Double Pink wire to terminal "I"
 - Double Black wire to "GND"
 - Single Gray wire to "S"
5. Reassemble the trim back into place after making all appropriate connections. Very important to secure the airbag back into place using all bolts removed.

Note: The airbag assembly needs to slide correctly onto the airbag bracket.

At this point you are finished with the installation of the selector (Bi-fuel only) and CNG fuel gauge.

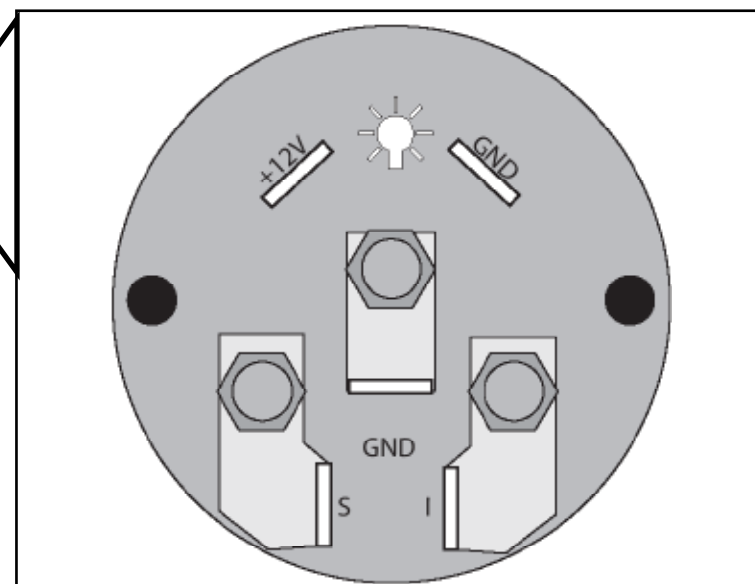

LEAK CHECKING THE SYSTEM

Leak test for a 2013 F-150 3.7L High Pressure Package

After the AITech-ECO CNG system has been installed on the vehicle, all fuel connections, fuel rails and injectors must be checked for leaks. Also check the overall installation of wiring, zip ties and components to make sure they are not loose or hanging.

Tools:

- Soapy Water Solution or Liquid Leak Check Solution
- Combustible Gas Leak Detector TPI 721 (Davis Instruments)
- Basic Hand Tools

1. Open the manual valve on the fuel tank. Rotate the manual valve by hand counter clockwise until fully open.
2. Fill the tank with CNG.
3. Check and verify that all installed hoses and fittings are not loose and are secure per torque specifications.
4. Double check and verify wiring is correct and secure with nothing hanging loose. Check that zip ties are snipped properly to avoid potential injury.
5. Pressurize the system by turning the ignition on but do not start the vehicle. This opens the solenoid and fills the lines.
6. Shut off the CNG at the cylinder (tank) manually (manual shut-off valve is located on the tank).
7. Use a methane detector, bubble soap, or other approved means to leak test all hoses, lines and fittings at connection points.
 - a. PASS: Continue to step 8.
 - b. FAIL: Turn off the vehicle ignition and double check that you have performed the manual shut-off on the cylinder (tank) valve. Locate any leak(s). Then, depressurize the system and correct the issue before continuing the leak test. Correcting a leak may simply require tightening (re-tightening) the hoses, lines or fittings. If a leak cannot be corrected, notify the appropriate personnel for further instructions.
8. Turn the ignition off, then back on and start the engine. This is to pressurize the lines again. While the engine is running, perform a leak test by using a methane detector, bubble soap, or other appropriate means.
 - a. PASS: Complete required paper work and notify your supervisor.
 - b. FAIL: Turn off the ignition and manually shut-off on the cylinder (tank) valve. Depressurize the system and correct any issues. After all corrections have been made, open the manual shut-off valve and start the engine. Run the leak test again. For un-repairable issues, notify appropriate personnel for further instructions.
9. Third party installers: After completing the final checklist, it is required that an original or a copy of the entire completed checklist be sent to AITech-Eco. Failure to do so will void the warranty and may result in suspension of installer's license. For additional information, contact your supervisor.

Open manual valve counter-clockwise until fully open.



INSTALLING THE CYLINDER COVER 8.9 GGE

Single Cylinder, Short Bed

Installing the cylinder cover is essentially the same for all vehicle models. Refer to *PREPARING THE TRUCK BED*, *INSTALLING THE FUEL TANK* and *INSTALLING THE FUEL LINES, COOLANT HOSES AND REAR WIRING HARNESS* before installing the cylinder cover.

Tools:

- Drill
- 3/8" Drill bit
- Hand tools
- Rivet Nut Setter

1. Place the cylinder cover (15.9CC6.5-D) over the cylinder assembly. The cylinder cover will be used as the template for marking drill points.
2. Measure 2 1/4" from top of bed to cover lip and mark.
3. Mark all four holes with a marker.
4. Remove the cylinder cover.

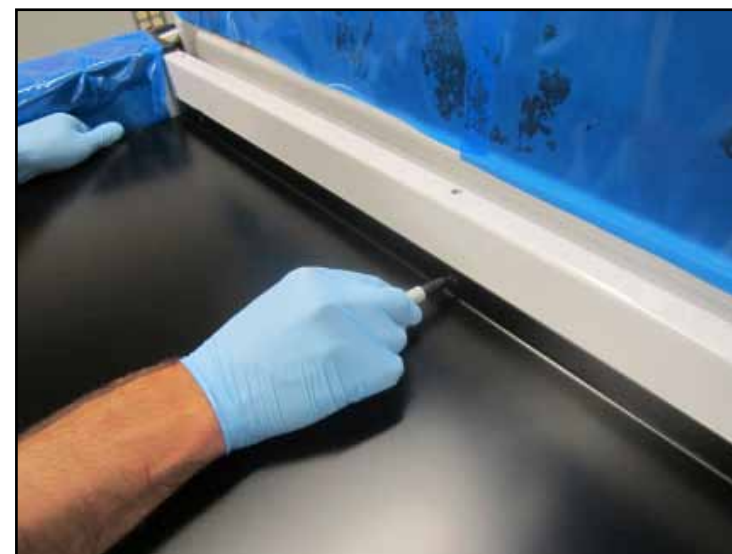
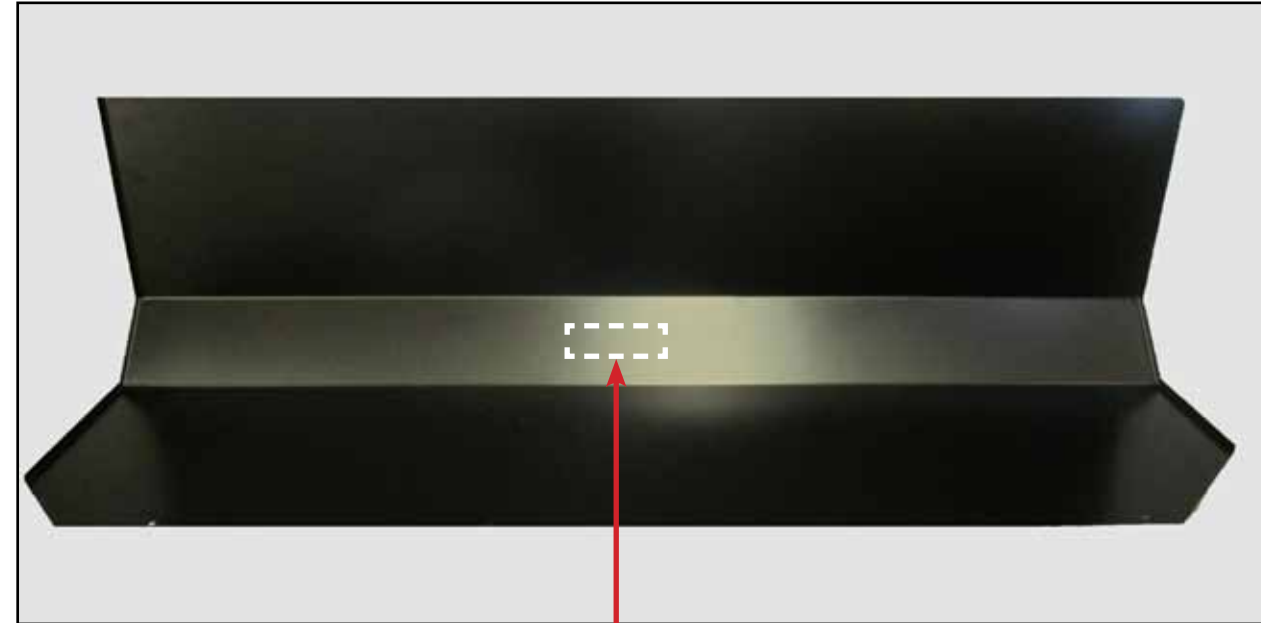

INSTALLING THE CYLINDER COVER 8.9 GGE

Single Cylinder, Short Bed

5. Drill a 3/8" hole using a drill bit. A unibit will also work.
6. Deburr and rust proof any exposed metal.
7. Install the polynut (47455) into each hole. Using the he rivet gun (no included), secure each four polynuts.
8. Install 4 u-nuts (111) onto the four slotted holes located on the rear cylinder plate.
9. Re-install the cylinder cover back over the cylinder assembly.
10. Using the 3/4" bolts (175-H) and secure the cover on top lip and bottom.
11. Apply decals in location shown. High pressure sticker (WHPSTKR) and Vinyl Logo.

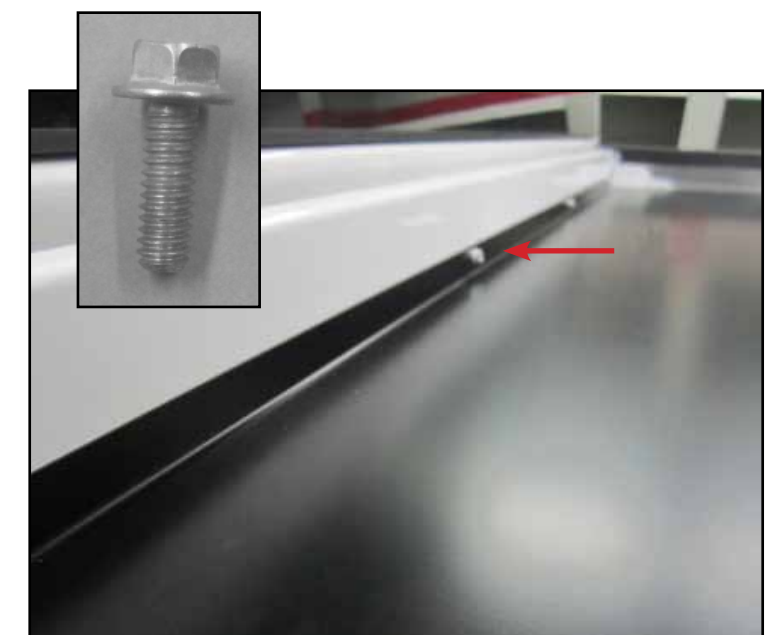
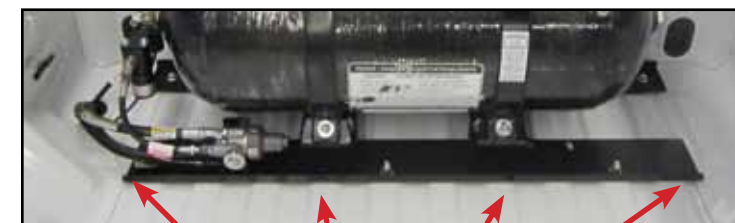

INSTALLING THE CYLINDER COVER 21.2 GGE

Single Cylinder, Short Bed

Installing the cylinder cover is essentially the same for all vehicle models. Refer to *PREPARING THE TRUCK BED*, *INSTALLING THE FUEL TANK* and *INSTALLING THE FUEL LINES, COOLANT HOSES AND REAR WIRING HARNESS* before installing the cylinder cover.

Tools:

- Drill
- 3/8" Drill bit
- Hand tools
- Rivet Nut Setter

1. Install four u-nuts (111) on the lip of the rear cylinder plate (150SBCRP).
2. Place decals in top of the cylinder cover (F-150Ded-SCC). Cover sticker inside (G-D0609). Warning: High pressure sticker outside the cover (WHPSTKR)
3. With assistance, carefully place cylinder cover over the cylinder.
4. Hand start the bottom bolts (175-H). Picture #2.
5. Pull the cover flat against the bed and mark the holes. Use cover as a template. Picture #4,5. Then remove the cylinder cover.

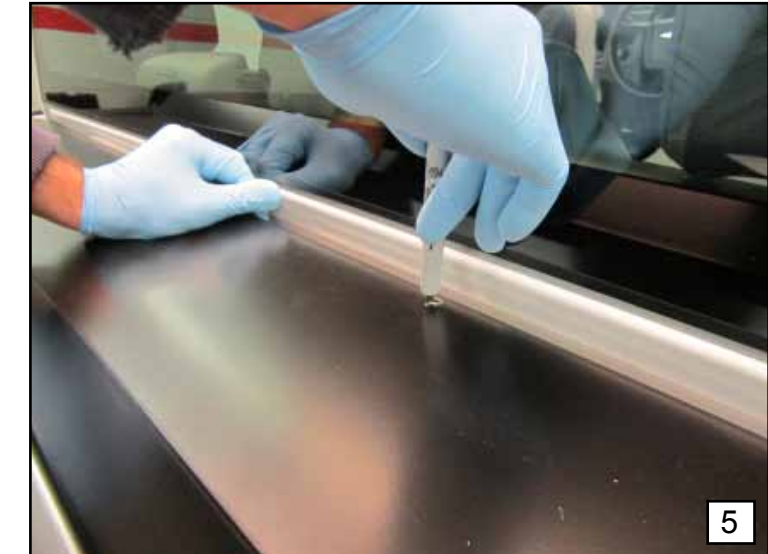
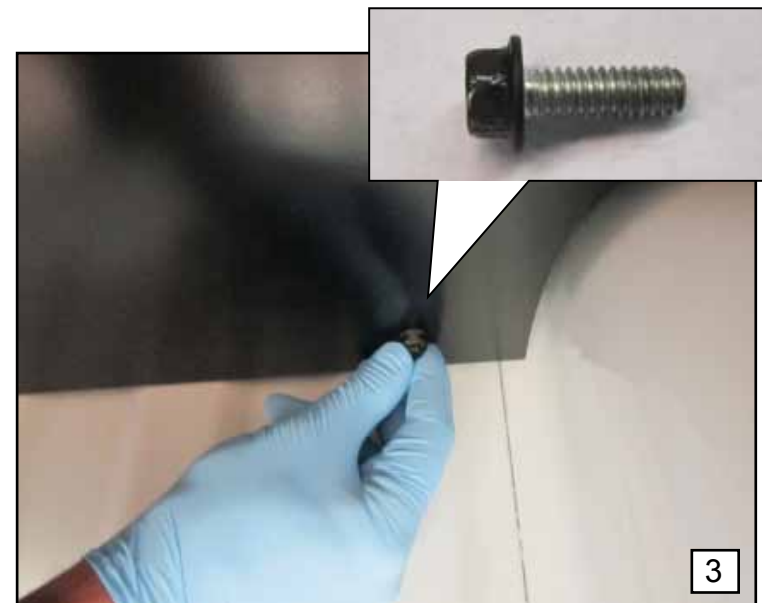
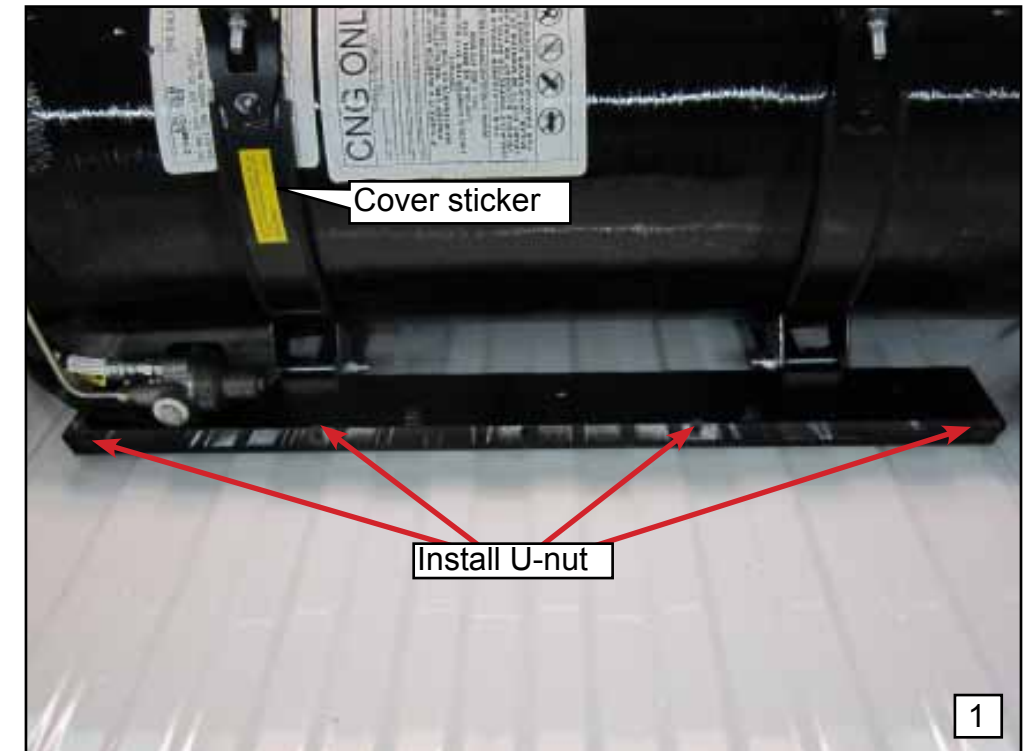
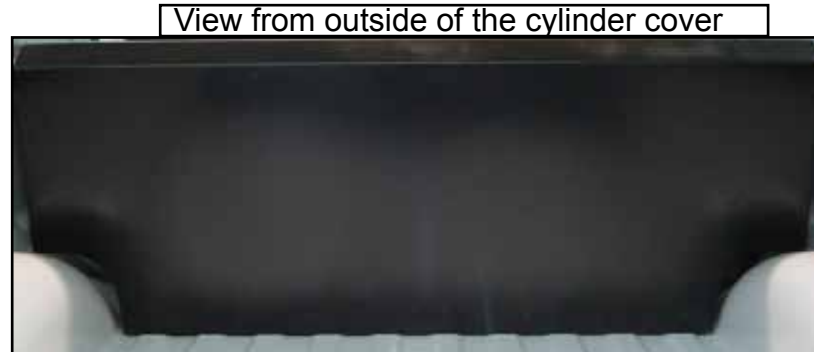

INSTALLING THE CYLINDER COVER 21.2 GGE

Single tank, short bed

6. Use a 3/8" drill bit size and drill all four holes where you marked. Rust proof any exposed metal. Picture #6.
7. Use a rivet nut setter and install a polynut (47455) in each hole. *Rivet nut setter not included.* Picture #7.
8. Install the cylinder cover. Wrench tighten all 8 (175-H) bolts. Picture #8.

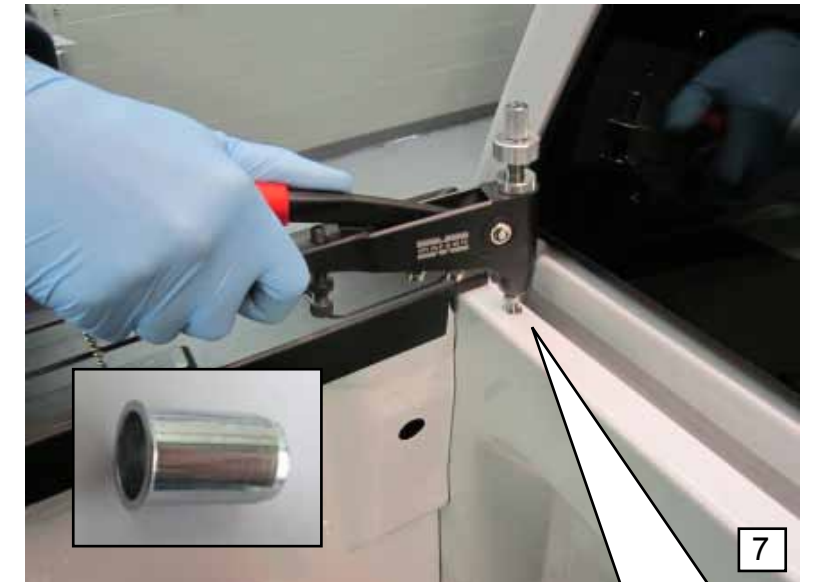

DECAL PLACEMENT

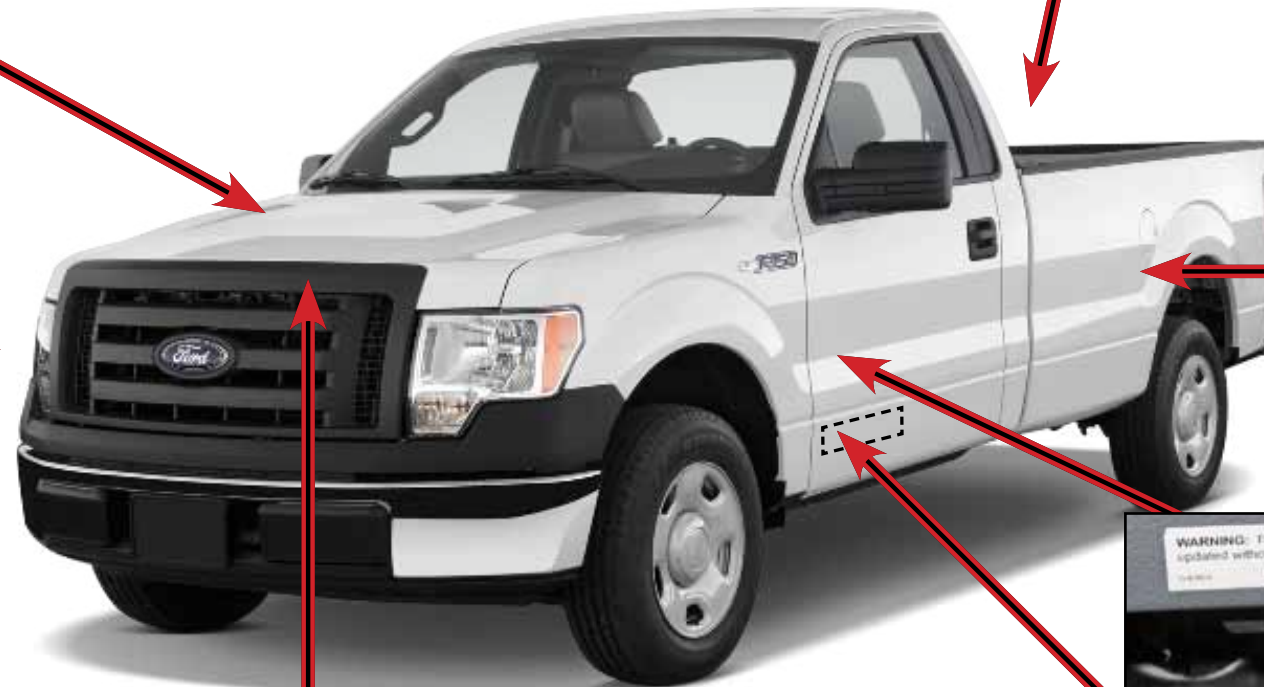

CNG ONLY Decal inside fuel fill cup



Contact Information

Sales Representative:	828-654-8300	sales@altecheco.com
Technical Support:	828-654-8300	customerservice@altecheco.com
Fax Number:	828-654-8747	
Toll Free Number:	828-654-8300	
AEC Hotline:	866-727-0326	

Address: 101 Fair Oaks Road, Arden NC 28704

2014 FORD F-150 3.7L COMPRESSED NATURAL GAS CONVERSION SYSTEM INSTALLATION INSTRUCTIONS

PARTS LIST

Product Description	Qty	AEC Part#
VEHICLE COOLANT ASSEMBLY		VCAF1_DB_3.7L
COOLANT Y'S	2	CHY
COOLANT HOSE, 16½x2 (33ft)	33	CH-B-H
FLEX GUARD SLEEVE (12.5ft)	12.5	FG-20
1¼ HEAT SHIELD (2ft)	2	HS1¼
LOW PRESSURE HOSE, B 13ft	1	MPH156
HOSE CLAMP, 17mm	4	HC17MM
HOSE CLAMP 3/4in	4	HC8-PF
P CLAMP 1 1/8in	8	PC1 1/8
P-CLAMP, 7/8in	4	PC7/8
M6-1 NYLOCK FLANGED NUT	1	(191)
12-14 x 1 SELF TAPPING SCREW	10	(135-H)
CAUTION: UP TO 150psi	2	PSI150
VEHICLE WIRING ASSEMBLY		WHF1_D_BiB_3.7L
AFCM	1	AFCM
AFCM BRACKET	1	150AFCMBR-6.2
BI-FUEL CYL CNG MAIN HARNESS (NO OBD II CONN.)	1	F150-3.7AFCM-BI-WH
CAN BUS PIGTAIL, TRUCK	1	CANBUS-M
SHRINK TUBE 1/8in, in inches	6	ST1/8DUAL-W
12-14 x 3/4in SELF TAPPING SCREW	2	(136-H)
REAR WIRING HARNESS	1	F150-3.7AFCM-RWH-B12-V
BI-FUEL SWITCH GAUGE HARNESS	1	F150BISWGA-MAR
FUEL GAUGE	1	MARSHALLGAUGE-LOGO
BI-FUEL SWITCH	1	AFCMBI-SWITCH
BI-FUEL INJECTOR WIRE HARNESS	1	F150-3.7INJWH
1/4-20 x 3/4 CHFB	2	(175-H)
1/4in-20 SHORT U-NUT	2	(111)
M6-1.0 FLANGED NYLOCK NUT	1	(191)
CABLE TIE 7.5in	18	CT-7.5-A
CABLE TIE PUSH MOUNT 8in	1	CTPM-8
POWER DISTRIBUTOR BRACKET	1	45998
DO NOT REFLASH	2	G-E0604-1

LOW PRESSURE COMPONENT ASSEMBLY (FUEL DELIVERY PRE ASSEMBLY)		INJASSE_3.7L
CNG FUEL INJECTOR	6	INJ824
FUEL RAIL	1	F150FR-3.7
ADAPTOR PLATE	1	F150MAP-3.7
FUEL RAIL BRACKET	1	F150FRB-1-3.7
FUEL RAIL BRACKET	1	F150FRB-2-3.7
F150 MANIFOLD SUPPORT BRACKET	1	F1MSB-3.7
TRANSDUCER, 200PSI	1	LOW PRESSURE SENSOR, BOSCH
HOLLOW HEX PLUG	2	HHP
STRAIGHT THREAD ELBOW. 90°	1	6 C5OLO-S ZJ
1/4in-20 x 3/4 CHFB	2	(175-H)
M6-1.0X75MM	6	F150-MAP-75MM
M6-1.0X140MM	1	F150-MAP-140MM
M4X0.7 10MM	8	(228-F)
VEHICLE FUEL FILL ASSEMBLY -SHORT BED		VFFF1_DBi_SB3.7L
FUEL FILL RING	1	FRR
FUEL RECEPTACLE HOUSING	1	FRH
3600psi RECEPTACLE	1	LD36
HIGH PRESSURE HOSE, 24in	1	HPH24ORFS-X
3/8in T x 9/16in SAE 90° ELBOW	1	6 F5OLO-SS-EX
FUEL HOUSING SCREW	6	(182)
WARNING HIGH PRESSURE STICKER	1	PSI3600-1
CNG ONLY 3600psi	1	CNGONLY-1
VEHICLE FUEL FILL ASSEMBLY -LONG BED		VFFF1_DBi_LB3.7L
FUEL FILL RING	1	FRR
FUEL RECEPTACLE HOUSING	1	FRH
3600psi RECEPTACLE	1	LD36
HIGH PRESSURE HOSE, 44in	1	HPH44ORFS-X
3/8in T x 9/16in SAE 90° ELBOW	1	6 F5OLO-SS-EX
FUEL HOUSING SCREW	6	(182)
P-CLAMP, 5/8in	1	PC5/8
12-14 x 1 SELF TAPPING SCREW	1	(135-H)

****Included with regulator

HIGH PRESSURE COMPONENT FUEL SYSTEM (CYLINDER ASSEMBLY)		VHPF13.7_D_8.9_BiSB
FRONT CYLINDER PLATE	1	F116FCP
REAR CYLINDER PLATE	1	F116X42RCP-6.5
SQUARE SPACER, 1 3/4x1 3/4x4 3/4	4	SP1.750X1.750X4.750
BRACKET SET	1	LX16104
CNG CYLINDER (15.9x42)	1	15.9X42
LYRA VALVE	1	LYRA
HIGH PRESSURE REGULATOR, 100psi	1	HPR100PSIA-GFI
****TRANSDUCER****	1	HP-TRANS-B
FILTER BRACKET	1	VGLRBRK
CNG FILTER HOUSING	1	HP-FH
COALESCENT FILTER	1	KIT-AFF-TIF-PE
HIGH PRESSURE HOSE, 11 1/2	1	HPH11.5ORFS
6 ORFS x 6 SAE ELBOW	2	6 C5OLO-S ZJ
6 ORFS x 6 SAE ST THREAD CONNECTOR	1	6 F5OLO-S-EX
SAE ORFS #6 X #8 SAE ML CONNECTOR	1	S6-8GC-CNG
CHECK VALVE	1	CH8S6SS6-1-316-CNG
6 SAEx6 SAE ADAPTOR	1	ISST6MST-CNG-EX
1/2-13x 3 CHFB BOLT	8	(198)
1/2-13 NYLOCK NUT	8	(043-H)
1/2 SAE FLAT WASHER	8	(040)
M8-1.25x16MM BOLT	4	(209)
VALVE STICKER	1	VWL
WARNING: HIGH PRESSURE	1	FHS
QVM COVER STICKER	1	G-D0609
WARNING HIGH PRESSURE STICKER	1	PSI3600-1
TANK SUB ASSEMBLY		(PART OF HIGH PRESSURE FUEL SYSTEM ASSEMBLY)
GROMMET, 2 1/8 GRW	1	2 1/8GRW
SPACER, 2x2x1/8	3	SP2X2X1/8
M12-1.75x110 BOLT	2	(149)
1/2-13x1 1/2 CHFB	3	(124-H)
1/2-13 NYLOCK NUT	3	(043-H)
1/2 SAE FLAT WASHER	3	(040)

2014 FORD F-150 3.7L COMPRESSED NATURAL GAS CONVERSION SYSTEM INSTALLATION INSTRUCTIONS

PARTS LIST

HIGH PRESSURE COMPONENT FUEL SYSTEM (CYLINDER ASSEMBLY)		VHPF13.7_D_15.7_BiSB
FRONT CYLINDER PLATE	1	F118FCP
REAR CYLINDER PLATE	1	F118X60RCP
SQUARE SPACER, 1 3/4x1 3/4x4 3/4	4	SP1.750X1.750X4.750
BRACKET SET	1	LN18404
CNG CYLINDER (18X60)	1	18X60
LYRA VALVE	1	LYRA
HIGH PRESSURE REGULATOR, 100psi	1	HPR100PSIA-GFI
****TRANSDUCER****	1	HP-TRANS-B
FILTER BRACKET	1	VGLRBRK
CNG FILTER HOUSING	1	HP-FH
COALESCENT FILTER	1	KIT-AFF-TIF-PE
HIGH PRESSURE HOSE, 18in	1	HPH18-EX
6 ORFS x 6 SAE ELBOW	2	6 C5OLO-S ZJ
SAE ORFS #6 X #8 SAE ML CONNECTOR	1	S6-8GC-CNG
CHECK VALVE	1	CH8S6SS6-1-316-CNG
6 SAEx6 SAE ADAPTOR	1	ISST6MST-CNG-EX
1/2-13x 3 CHFB BOLT	8	(198)
1/2-13 NYLOCK NUT	8	(043)
1/2 SAE FLAT WASHER	8	(040)
M8-1.25x16MM BOLT	4	(209)
VALVE STICKER	1	VWL
WARNING: HIGH PRESSURE	1	FHS
QVM COVER STICKER	1	G-D0609
WARNING HIGH PRESSURE STICKER	1	PSI3600-1
TANK SUB ASSEMBLY		(PART OF HIGH PRESSURE FUEL SYSTEM ASSEMBLY)
2 1/8in GROMMET, WIDE GROVE	1	2 1/8GRW
2 x 2 x 1/8in BACKING PLATE	3	SP2x2x1/8
TUBE SPACER	3	F150-6.5BEDSP
M12-1.75 x 110mm CHFB	2	(149)
1/2in-13 x 4 1/2in CHFB	3	(167)
1/2in-13 NYLOCK NUT	3	(043-H)
1/2in-SAE WASHER	3	(040)

HIGH PRESSURE COMPONENT FUEL SYSTEM (CYLINDER ASSEMBLY)		14_VHPF13.7Bi__SB21.2
SINGLE CYL MOUNTING PLATE, FRONT	1	CFMPF150
SINGLE CYL MOUNTING PLATE, REAR, (SHORT BED 6.5ft)	1	150SBCRP-GFI
MOUNTING SUPPORT RINGS, set	1	21-STRAPBRKT
CNG CYLINDER (21 x 60) w/ PLUG	1	LINCOLN 21.2 GGE
VEGA VALVE	1	VEGA
FILTER HOUSING	1	HP-FH
FILTER ELEMENT W/ O-RING	1	KIT-AFF-TIF-PE
VEGA FILTER BRACKET	1	VEGABRK
HP REGULATOR 100 psi.	1	HPR100PSIA-GFI
****TRANSDUCER****	1	HP-TRANS-B
HIGH PRESSURE HOSE, 19.5, RED	1	HPH19.5-EX
2in PLUG w/O-RING	1	16065-90
CHECK VALVE	1	CH8S6SS6-1-316-CNG
6 SAE x 6SAE ADAPTOR	1	6 F50HA0-S ZJ
3/8 ORFS x 9/16 SAE ELBOW	2	6 C5OLO-S ZJ
6 ORFS x 6 SAE ST THREAD CONNECTOR	1	6 F5OLO-S ZJ
SAE ORFS #6 X #8 SAE ML CONNECTOR	1	S6-8GC-CNG
1/2-13 x 1 1/4 CHFB	4	(117-H)
1/2-13 x 1 1/2 CHFB	4	(124-H)
1/2 SAE FLAT WASHER	8	(040)
1/2-13 NYLOCK NUT	8	(043-H)
M8-1.25 x 16mm BOLT	4	(209)
VALVE STICKER	1	VWL
"WARNING STICKER: HIGH PRESSURE..." (RED ON SILVER)	1	FHS
QVM COVER STICKER	1	G-D0609
WARNING 3600psi	1	PSI3600-1
TANK SUB ASSEMBLY		(PART OF HIGH PRESSURE FUEL SYSTEM ASSEMBLY)
2 1/8in GROMMET, WIDE GROVE	1	2 1/8GRW
2 x 2 x 1/8in BACKING PLATE	3	SP2x2x1/8
TUBE SPACER	3	F150-6.5BEDSP
M12-1.75 x 110mm CHFB	2	(149)

1/2in-13 x 4 1/2in CHFB	3	(167)
1/2in-13 NYLOCK NUT	3	(043-H)
1/2in-SAE WASHER	3	(040)
VEHICLE KIT INFORMATION		VKIF13.7_D_Bi
F-150 OWNER'S MANUAL	1	F150 OWNERS
MAIN WIRING HARNESS DIAGRAM	1	F-1503.7MHD-D-Bi
PCM PIN-OUT REFERENCE	1	F150 PIN OUT
CNG BLUE DIAMOND STICKER	1	CNG-STKR
2014 Bi-FUEL EPA CONVERSION DECAL	1	
NGV DECAL-GREEN	2	NGVSTKR
WARNING 3600psi	2	PSI3600-1
VEHICLE REAR LOGO	1	ADVINYL
CNG FUELED VEHICLE STICKER	1	CNFV
CONVERSION CHECKLIST	1	CHECKLIST
PCM REQUEST FORM	1	PCM REQUEST
WARRANTY INFO	1	WARRANTY INFO